

*Encore*<sup>®</sup>

Router Carved Doors

*Ovation*<sup>®</sup>

Layered Panel Doors

*Infinity*<sup>®</sup>

Inlaid Molding Doors

*Bravo*<sup>®</sup>

Traditional Stile & Rail Doors

Traditionally  
Modern



## Your Design Opens With Our Doors



The Millennium Collection consists of four distinct door products that each fit a specific demand in the world of design and construction. Encore, Ovation, Infinity, and Bravo Doors are all manufactured of renewable composite wood fiber materials for stability and reliability. Our state-of-the-art design and environmentally friendly construction techniques mean endless flexibility for your architectural design. The Millennium Collection will provide unique solutions to any paint grade door application requirement. Take a moment to go through this catalog and you will begin to understand the value and excitement that these doors can bring to your special project.

## *Encore*® Router Carved Doors 4

Cost-effective dramatic raised panel and grooved options created by our state-of-the-art computer routing equipment.

## *Ovation*® Layered Panel Doors 12

Unique layered construction with unlimited design options to compliment any architectural style

## *Infinity*® Inlaid Molding Doors 20

Striking appearance featuring dramatic raised panels with detailed inlaid raised molding profiles

## *Bravo*® Traditional Stile & Rail Doors 29

Featuring traditional doweled stile and rail construction allowing classic millwork details with crisp miters and joinery

## Specialty Doors 34

White Laminate Glass, Mirror, Louver, Dry Erase, Chalkboard, Barn, Bifold and Radius Doors

***The Millennium Collection is part of the Doormerica Products family. Please visit [www.doormerica.com](http://www.doormerica.com) for more information.***



# Encore® Router Carved Doors



Each door is individually carved to exacting tolerances by our CNC computer driven routing equipment and is constructed of laminated MDF with our patented Integra-Lok® stiles for maximum screw holding performance. The result is a beautiful door that offers extreme design flexibility. The unique construction process of our Encore Router Carved Doors allows for intricate and virtually unlimited design possibilities.

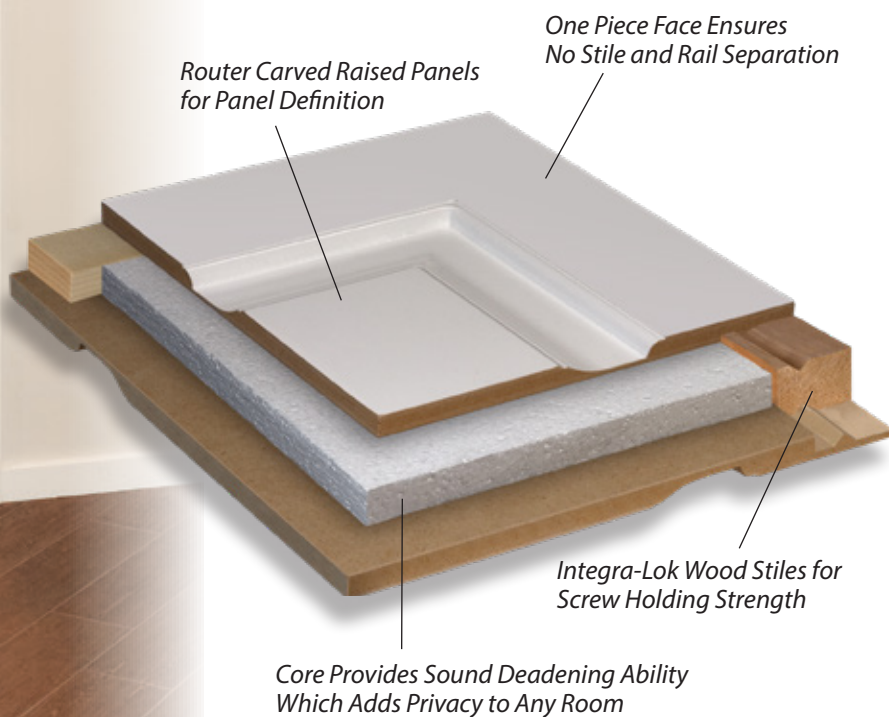

- Dramatic raised panels or grooved options
- Traditional molding profiles
- Custom design flexibility
- 152 Designs Available
- Solid surface construction
- No possibility of stile and rail separation
- State of the art production capability
- Factory primed
- Integra-Lok stiles for screw holding performance
- Environmentally friendly, can help earn LEED credits
- Made in the USA by proud American craftsmen
- Limited Lifetime interior warranty



We offer 152 standard designs or you may create your own special design. Our engineering lab will be happy to review any custom request. Encore Router Carved Doors, with foam core or optional solid MDF core, are available in 1-3/4" and 1-3/8" thickness.





**Fire Rating:**

Up to 90-minute positive pressure fire ratings available with solid intumescent core. Maximum size 20-minute up to 8/0 x 8/0 pairs. 45 thru 90-minute up to 7/0 x 8/0 pairs. For more detailed fire rating information, visit our website at [www.doormerica.com](http://www.doormerica.com)

**STC (Sound Transmission Class)**

Encore door panels carry comparably high ratings per ASTM E90-90. Our standard 1-3/4" MDF solid core door was certified at STC 36 with several seal systems available. Millennium doors were tested and certified by Pemko and by Architectural Testing in York, PA. Other STC information can be seen on our website at [www.doormerica.com](http://www.doormerica.com) or by speaking to one of our Sales Representatives.

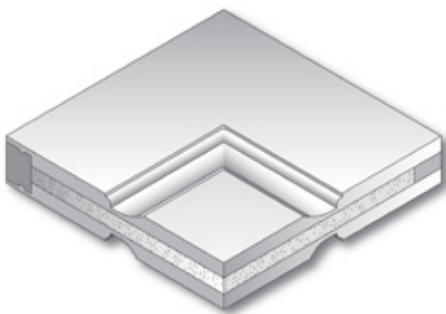

Encore Standard Sticking Profile

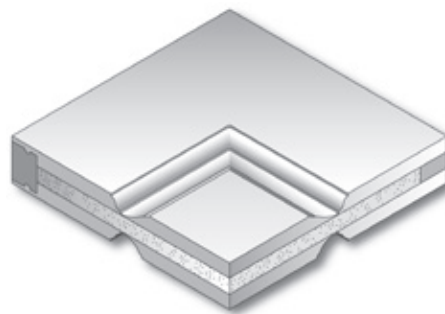

Encore Ogee Sticking Profile

**Specifications:**

- Traditional router raised panel design provides uniform structural support. Seamless stile and rail with no possibility of separation. Will not shrink, split or warp.
- Doors available in 1-3/8" or 1-3/4" thickness.
- Doors available up to 4/0 in width and 8/0 in height.
- Moisture resistant type 1 glue internal construction.
- Architecturally correct door weight. Foam core keeps door weight consistent with standard stile and rail doors.
- Primed all six sides, ready to start the finishing process (see care & finishing instructions)
- One or both sides routed or separate designs on each side.

The *Integra-Lok*® wood edge  
U.S. PATENT #7,210,274

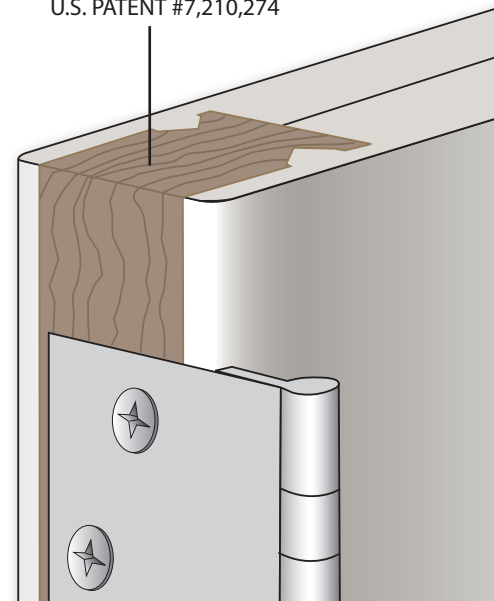

**NEW!**

# Encore<sup>®</sup> Contemporary Collection

Each door is individually carved to exacting tolerances by our CNC computer driven routing equipment and is constructed of laminated MDF with our patented Integra-Lok<sup>®</sup> stiles for maximum screw holding performance. The result is a beautiful door that offers extreme design flexibility. The unique construction process of our Encore Router Carved Doors allows for intricate and virtually unlimited design possibilities.

- New modern designs enhance any contemporary project
- State of the art construction
- Solid surface construction with no possibility of stile and rail separation
- Factory primed and ready for painting
- Integra-Lok stiles for screw holding performance
- Environmentally friendly
- Made in the USA





# 6701

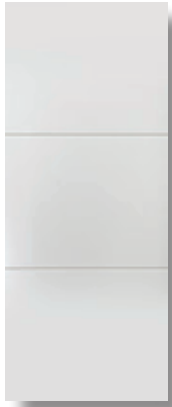

# 6653

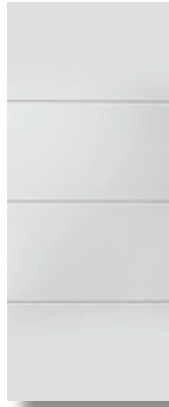

# 6654



# 6652

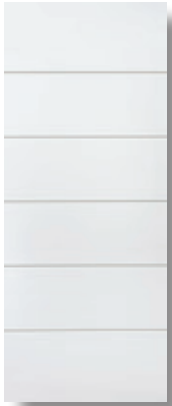

# 6650



# 6707



# 6657



# 6656



# 6702



# 6655



# THE MILLENNIUM<sup>®</sup> COLLECTION



# Encore® Standard Designs

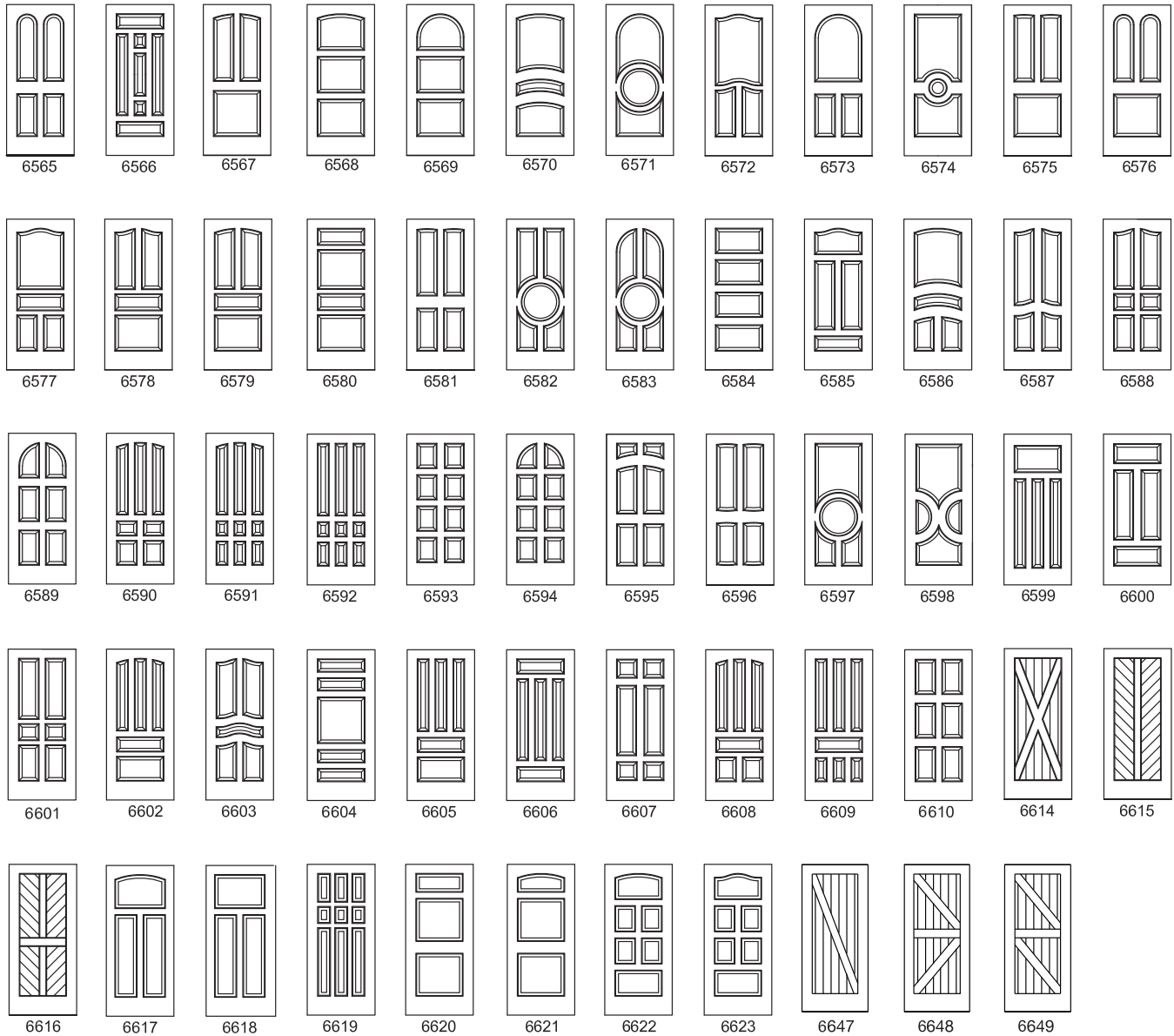

## Contemporary Designs

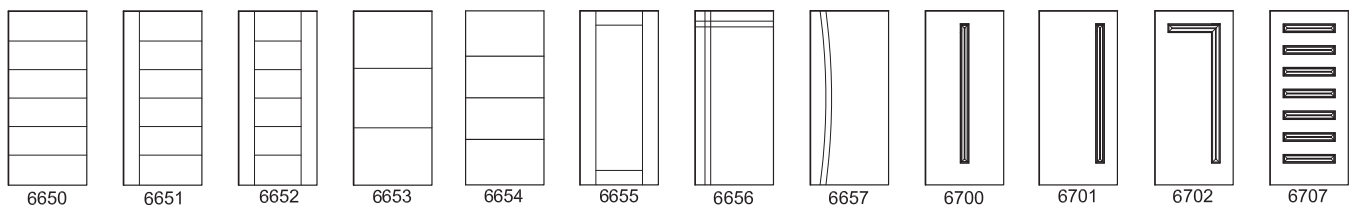

# Ovation® Layered Panel Doors

The revolutionary Ovation Door is precision crafted from components made of medium density fiberboard. This stable wood-based material is an environmentally friendly substrate that will not split or warp and provides a smooth paintable surface.

- Uniquely layered construction
- 146 standard designs, plus custom design flexibility
- Doors available in 1-3/8" or 1-3/4" thickness
- Doors available up to 4/0 in width and 8/0 in height
- Integra-Lok® wood edge for screw holding strength
- Limited Lifetime interior warranty
- Environmentally friendly, can help earn LEED credits
- Made in the USA by proud American craftsmen
- Factory Primed

*Crafted from an Environmentally Friendly Substrate for a Smooth Paintable Surface*

*One Piece Face Ensures No Stile & Rail Separation*

*Available With Solid Raised or Flat Panel Designs*

*Integra-Lok® Wood Stile for Screw Holding Strength*



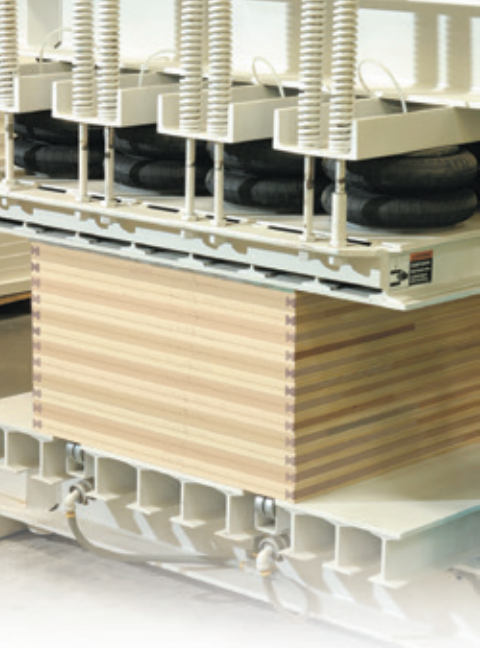

The *Fiberfuse*® process bonds the pre-machined sheets into a layered composite under extreme pressure. Exterior grade type one glue is utilized for strength and durability. Technology, engineering and craftsmanship come together to make the Ovation Door superior to any other composite door product on the market.

Our patented *Integra-Lok*® wood edge is keyed and bonded into the edge of every Ovation Door utilizing our *Fiberfuse*® process. This unique design feature will not allow the wood edge to pull out and ensures screw holding strength. Ovation doors are for interior use only.

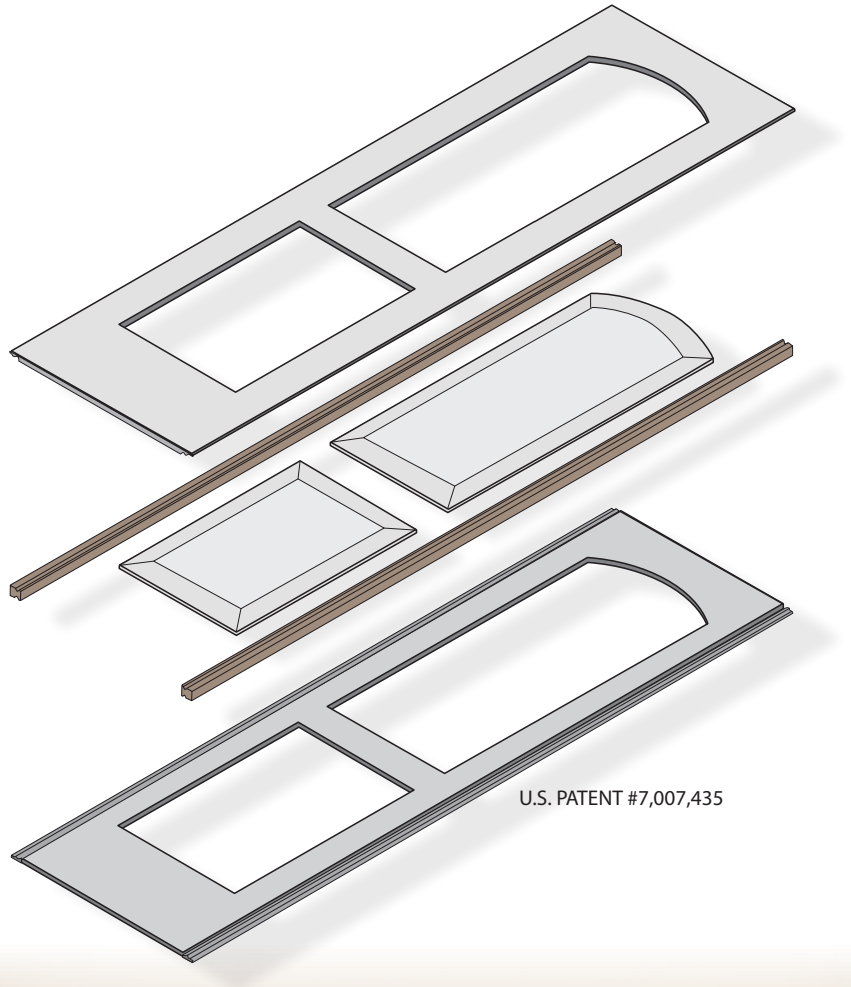

U.S. PATENT #7,007,435

The *Integra-Lok*® wood edge  
U.S. PATENT #7,210,274

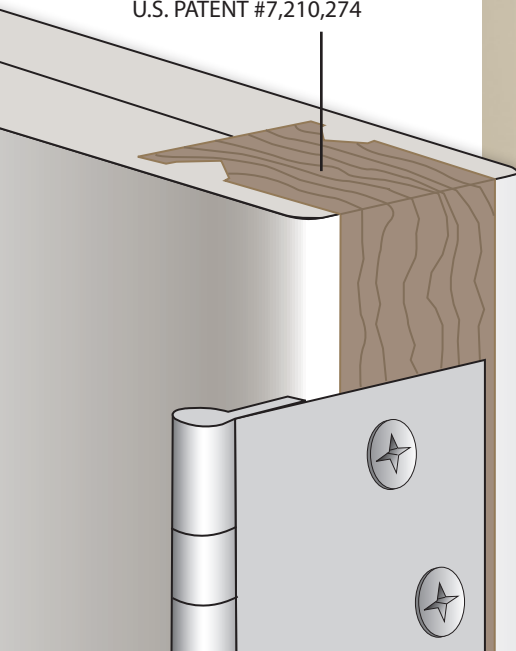

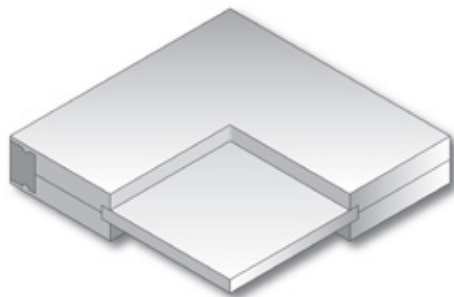

**No Sticking** • Shown with Flat Panel option



**No Sticking** • Shown with Raised Panel option\*

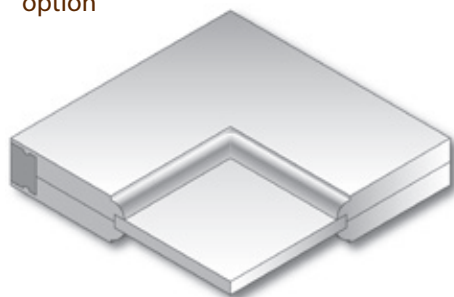

**Round Sticking** • Shown with Flat Panel option



**Round Sticking** • Shown with Raised Panel option\*

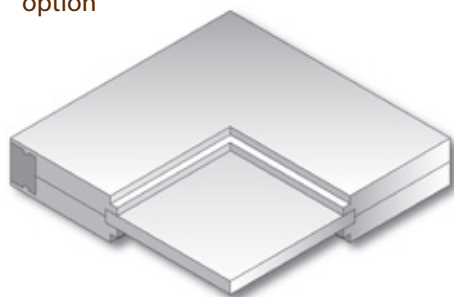

**Square Sticking** • Shown with Flat Panel option

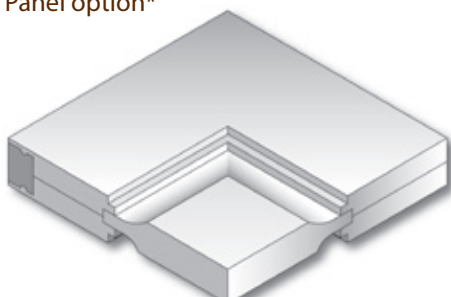

**Square Sticking** • Shown with Scoop Panel option

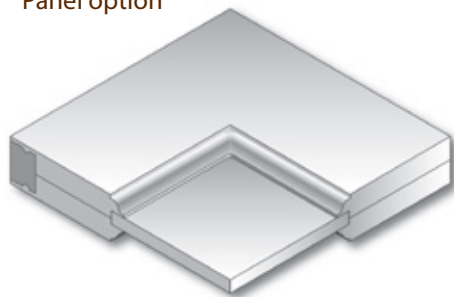

**Ogee Sticking** • Shown with Flat Panel option

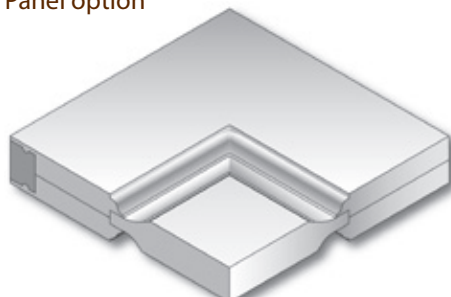

**Ogee Sticking** • Shown with Raised Panel option\*

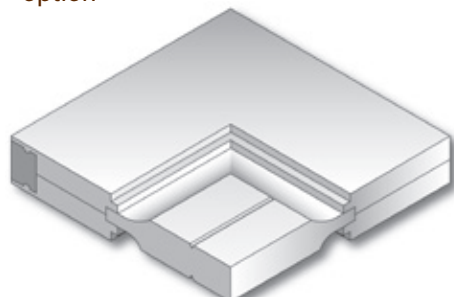

**Square Sticking** • with V-Groove Panel option

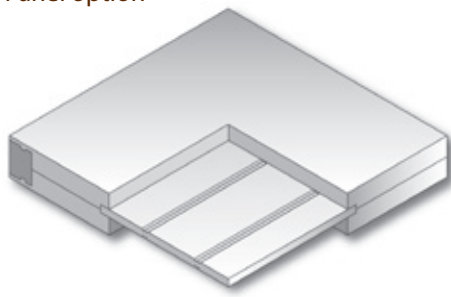

**No Sticking** • Bead Board Panel

\*Also available in scoop raised panel

**Fire Rating:**

Up to 90-minute positive pressure fire ratings available with 5/8" flat panel single doors, 7/8" flat panel pairs. Maximum size 20-minute up to 8/0 x 8/0 pairs. 45 thru 90-minute up to 7/0 x 8/0 pairs. For more detailed fire rating information, visit our website at [www.doormerica.com](http://www.doormerica.com)

**STC (Sound Transmission Class)**

Ovation door with 1-1/4" raised panels carry comparably high ratings per ASTM E90-90. Our 1-3/4" door with 1-1/4" raised panel was certified at STC 34 and our 90-minute intumescent core door had a STC rating of 34 both using approved seals and approved automatic door bottom. Millennium doors were tested and certified by Intertek in Courtland, NY. Other STC information can be seen on our website at [www.doormerica.com](http://www.doormerica.com) or by speaking to one of our Sales Representatives.





# Ovation® Bolection Molding Option

Solid, time-tested construction allowing you to choose between a variety of flat and raised panels and four sticking options, can now be further enhanced with our new Bolection molding option.

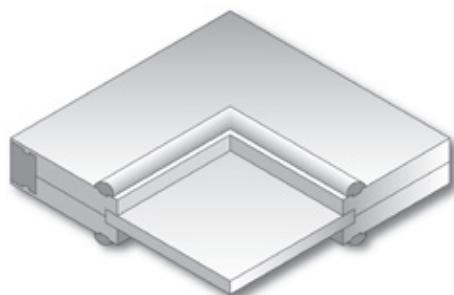

No Sticking • Small Bolection



No Sticking • Large Bolection

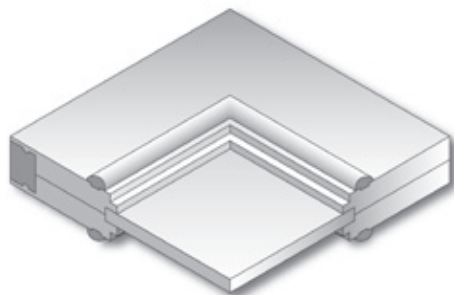

Square Sticking • Small Bolection

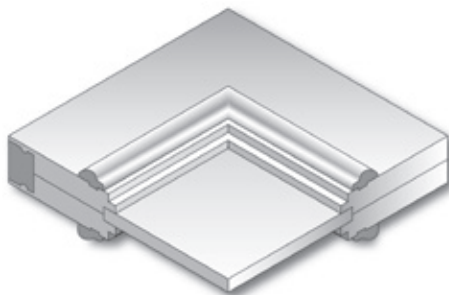

Square Sticking • Large Bolection



Round Sticking • Small Bolection

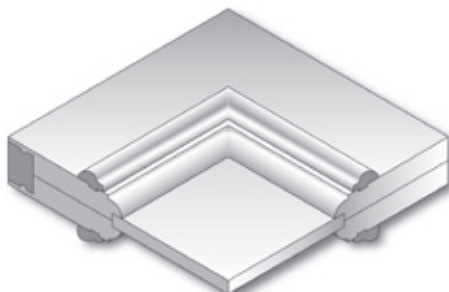

Round Sticking • Large Bolection



Ogee Sticking • Small Bolection

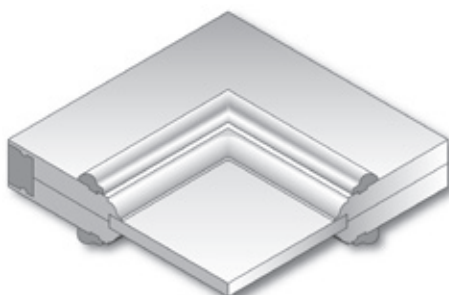

Ogee Sticking • Large Bolection

*\*All shown with flat panel option.*

## LARGE



Offered in two different profiles, large and small, these moldings are inlaid around the edge of the door panels. While some designs are limited due to space, Bolection moldings add another layer of depth – beautifully complimenting the appearance of the door and bringing special detail to your project or home.

## SMALL



# THE MILLENNIUM<sup>®</sup> COLLECTION

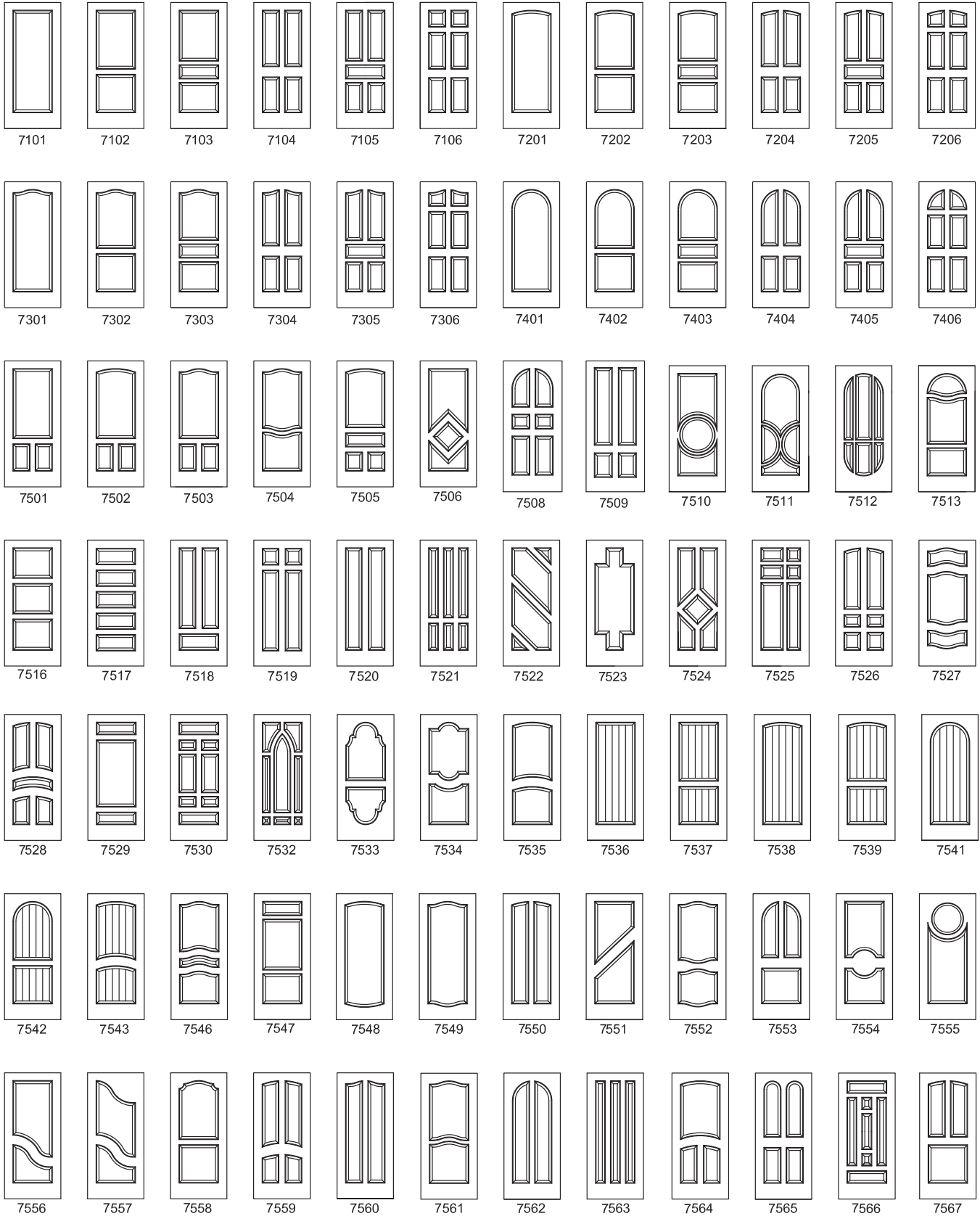

# Ovation® Standard Designs



# *Infinity*® Inlaid Molding Doors

PATENT #5,918,434



Uniquely designed composite doors with raised panel appearance and decorative raised molding. The elegant appearance and superior value of Infinity Inlaid Molding Doors make them the perfect choice for any project. No other door can offer this combination of beauty, detail, function and value.

- Features dramatic raised panels
- Detailed inlaid molding profiles: Raised, Flush and Plant-on
- Patented, integral panel design
- 138 standard designs, plus custom design flexibility
- Doors available in 1-3/8" or 1-3/4" thickness
- Doors available up to 4'0" in width and 10'0" in height
- Limited Lifetime interior warranty
- Environmentally friendly, can help earn LEED credits
- Made in the USA by proud American craftsmen
- Factory Primed

*Raised Inlaid Molding for a Dramatic Appearance*

*Primed on All Six Sides Ready to Paint*



*Solid Continuous Particle Board Core for Noise Reduction*

*Wood Stiles for Screw Holding Strength*

## 1000 SERIES

***Infinity Standard Series*** molding with raised panels create a dramatic impression.

## 2000A SERIES

***Infinity Architectural Series*** molding enhances the scale and proportion on larger doors.

## 2000D SERIES

***Infinity Designer Series*** molding adds intricate detail for a striking appearance.



Our patented solid core premium construction features MDF raised inlaid molding and a dramatic raised panel.

138 standard designs are offered and custom design layouts are available in 1-3/4" and 1-3/8" thick configurations up to 4/0 x 10/0.

**Infinity Doors** are offered in three different raised molding profiles with the accompanying flush molding for bypass or pocket applications.

*Infinity Series* molding creates traditional and contemporary design layouts. Perfect for more intricate designs and panel layouts.

*Architectural Series* molding has been developed to enhance the appearance of larger size doors (1-3/4" doors only).

Our dramatic *Designer Series* molding makes a bold statement. When your design calls for the ultimate in a high profile raised molding, choose Infinity Doors Designer Molding (1-3/4" doors only).

**Specifications:**

- Patented precision design with integral panels provides uniform structural support. Seamless stile and rail with no possibility of separation. Will not shrink, split, warp or move.
- Doors available in 1-3/4" and 1-3/8" thick and feature a smooth MDF surface.
- Internal stiles have one-inch width softwood.
- Solid continuous particleboard core.
- Primed all six sides ready to begin the finishing process (see care and finishing instructions).
- Customized designs are available. Our engineering lab will review all design requests.
- Quality crafted with environmentally friendly materials in the United States.



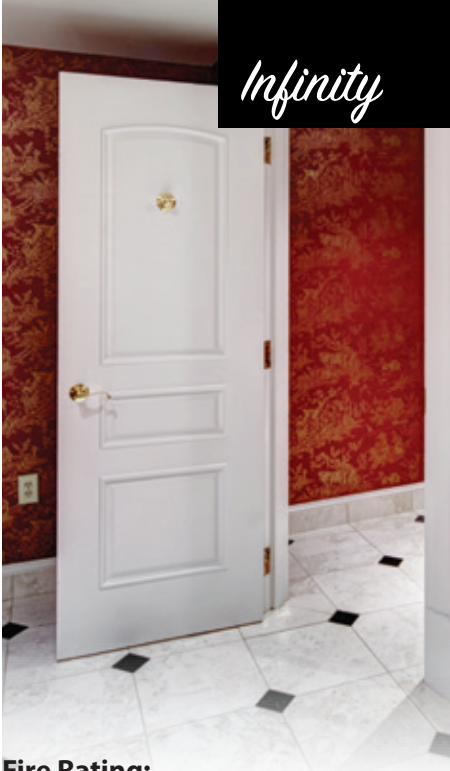

**Fire Rating:**  
20-minute positive pressure fire ratings available with all three styles of molding. 45 thru 60-minute mineral core Infinity standard double lipped raised molding only. Maximum size for intumescent core is up to 7/0 x 8/0 pairs; Mineral core maximum size is up to 8/0 x 9/0 pairs. For more detailed fire rating information, visit our website at [www.doormerica.com](http://www.doormerica.com)

**STC (Sound Transmission Class)**  
Infinity door panels carry comparably high ratings per ASTM E90-90. Our standard 1-3/4" thick door was certified at STC 34 using approved seals and approved automatic door bottom. Recently we added a STC 43 and 45 door to the Infinity with plant-on molding line up using a special core and seals. Millennium doors were tested and certified by Intertek in Courtland, NY. Other STC information can be seen on our website at [www.doormerica.com](http://www.doormerica.com) or by speaking to one of our Sales Representatives.

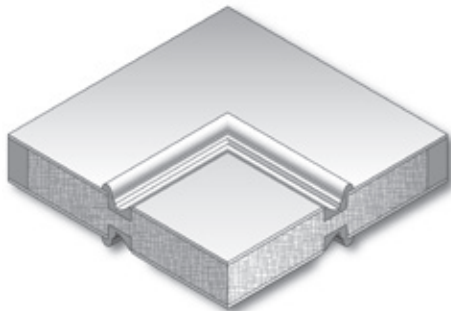

1000 Series Standard Raised

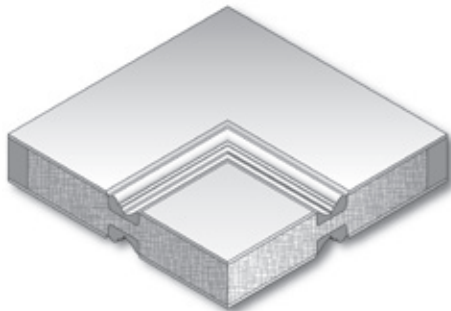

1000 Series Standard Flush

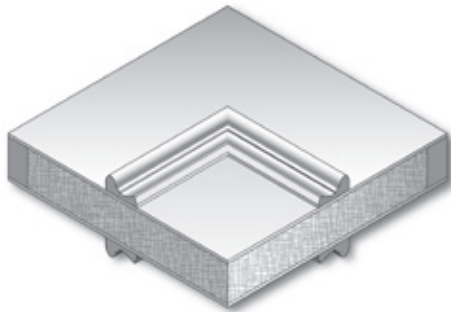

1000 Series Standard Plant-on

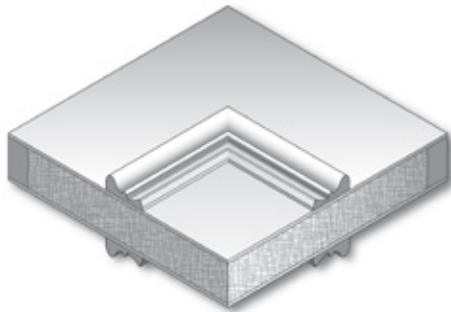

2000 Series Architectural Plant-on

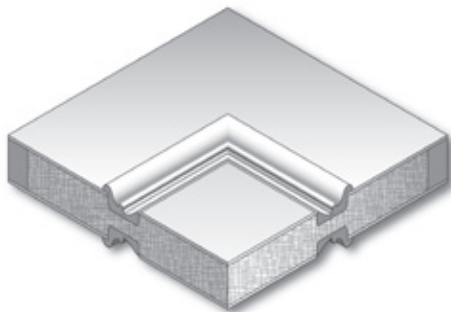

2000 Series Architectural Raised

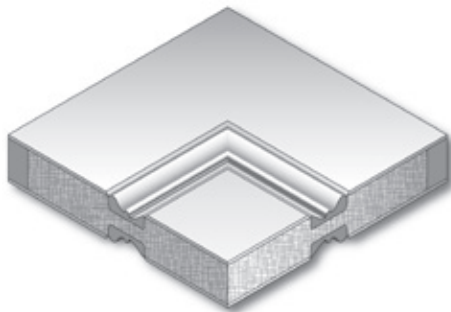

2000 Series Architectural Flush

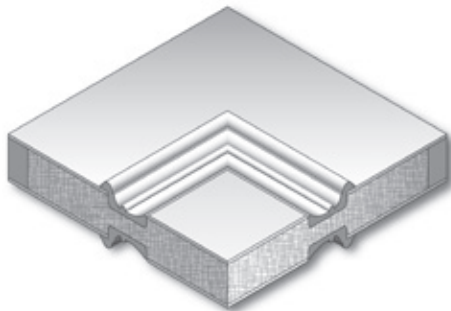

2000 Series Designer Raised

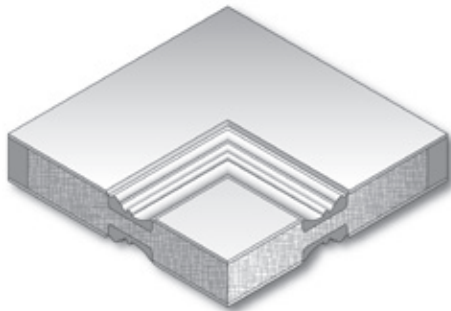

2000 Series Designer Flush



# Infinity<sup>®</sup> Contemporary Collection



Millennium's Infinity Contemporary Collection of solid core doors feature clean lines and distinctive style. Sixteen modern uncluttered designs that favor strong lines and a clean artistic flair. Defining a contemporary design these simple low profile moldings bring a current feel to any aesthetic. Focused on function, Infinity's flush contemporary molding avoids excess and sets the tone for an understated design. Take a moment to contemplate all of the subtleties of the Infinity Contemporary Collection.





1700



1701



1702



1707



1721



1722



1723



1731



1733



1742

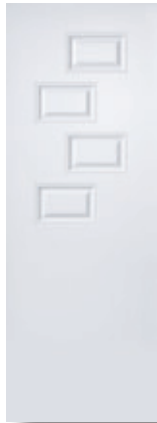

1744

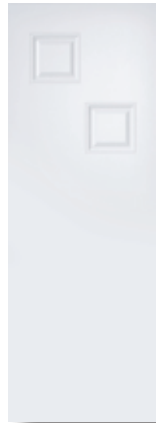

1752



1753



1760



1761



1763



# THE MILLENNIUM<sup>®</sup> COLLECTION

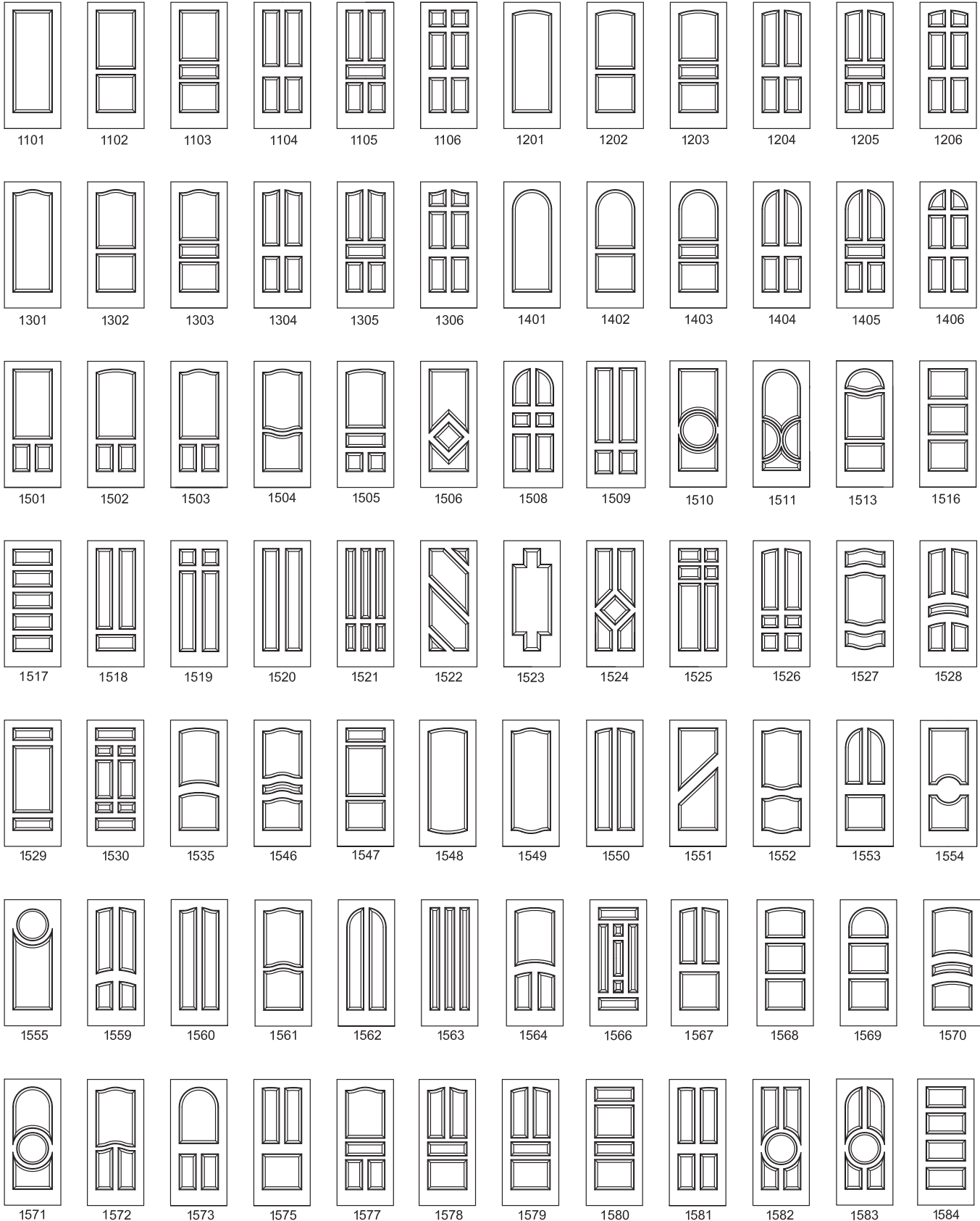

# Infinity® Standard Designs

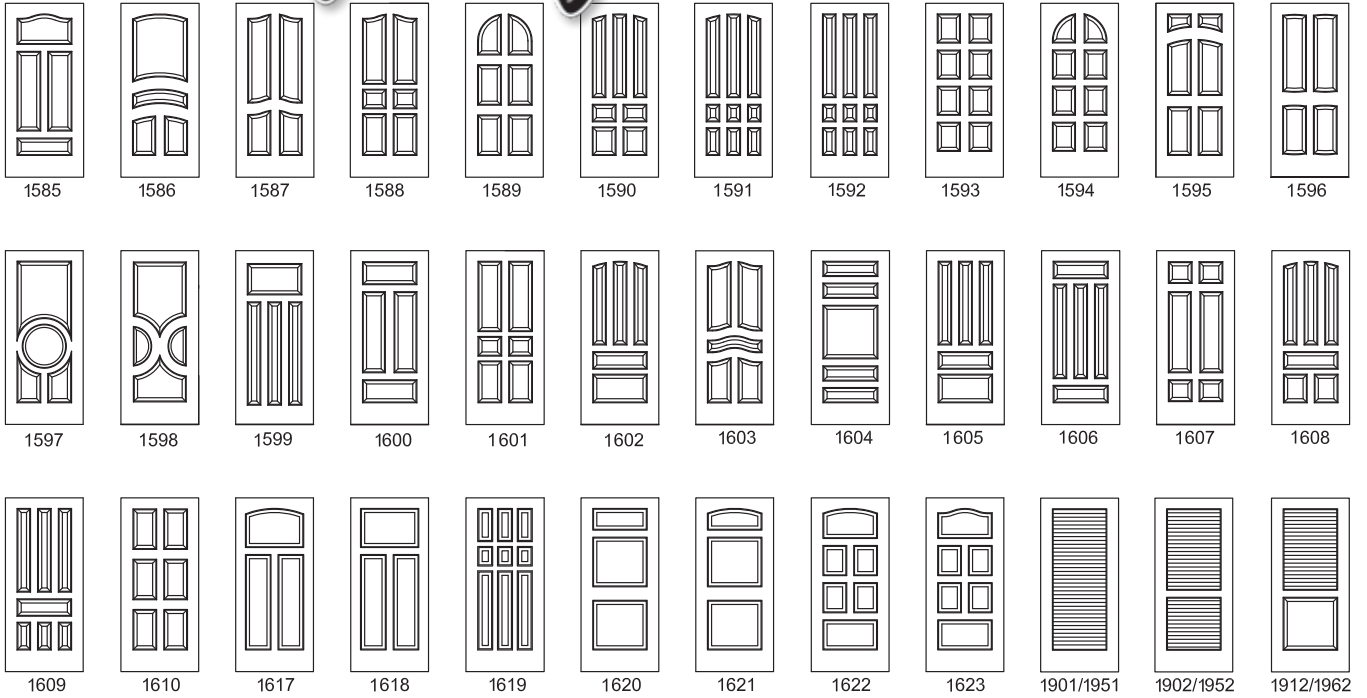

## Contemporary Designs

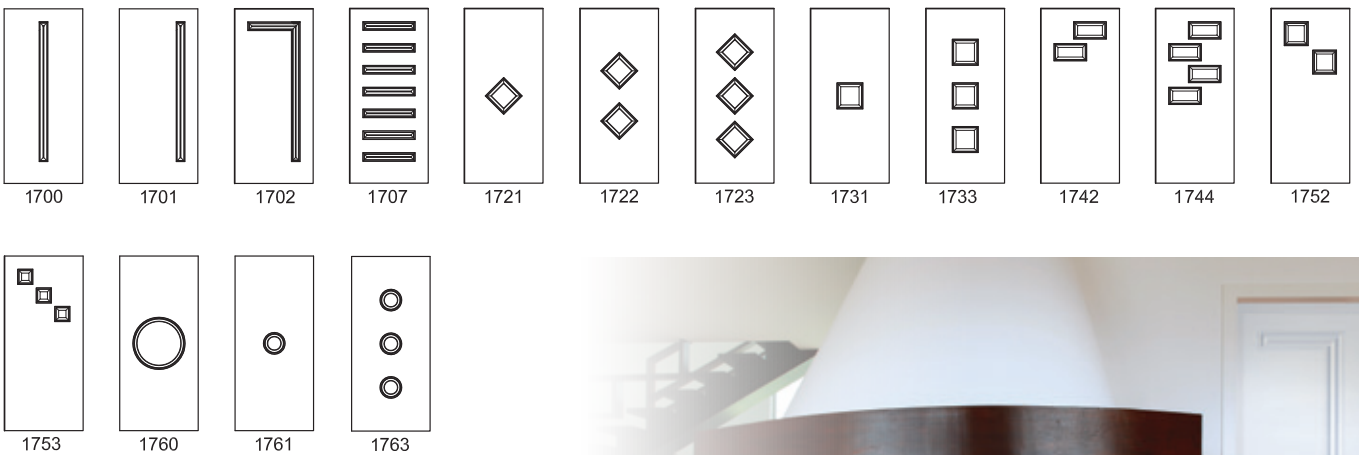





# Bravo® Traditional Stile & Rail Doors



Sometimes you need to refer to history to achieve traditional millwork detail. Millennium Door's Bravo Doors are built exactly like wood doors made centuries ago. Featuring traditional doweled stile and rail construction following classic millwork details and joinery. Separate stiles, rails and panels are assembled by hand utilizing twenty-first century technology. Made from highly refined MDF a stable and abundant wood fiber material. Utilizing modern materials and state of the art equipment, Bravo delivers the best of both worlds.

- 51 Traditional Stile and Rail Designs
- Crisp Detailed Miters and Profiles
- Doweled and Bonded Construction
- Architecturally Correct Panel Configuration
- Custom Design Capability
- Doors available in 1-3/8" or 1-3/4" thickness
- Doors available up to 4/0 in width and 9/0 in height
- Made from Stable MDF
- Warp and Bow Resistant
- Factory Primed
- Easy to Paint
- 20 Minute Fire Ratings
- Environmentally friendly, can help earn LEED credits
- Made in the USA by proud American craftsmen

# Classic Construction Meets Modern Technology

If you have a historic renovation project or are just looking for the most traditional wood door detail you can find, Bravo is the answer. Built with state of the art computer controlled manufacturing process, utilizing environmentally responsible materials and proudly assembled by skilled craftsmen in the United States.

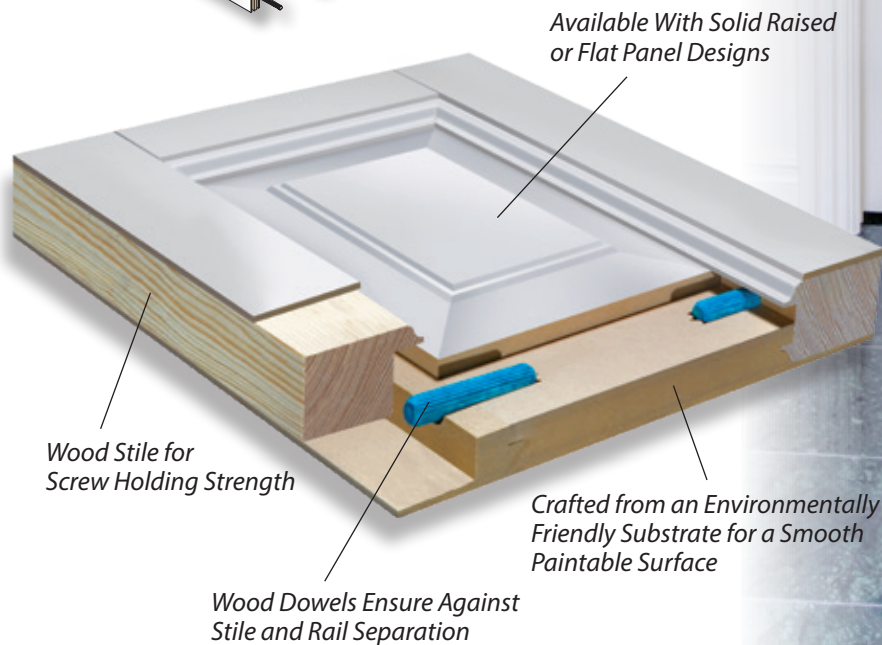
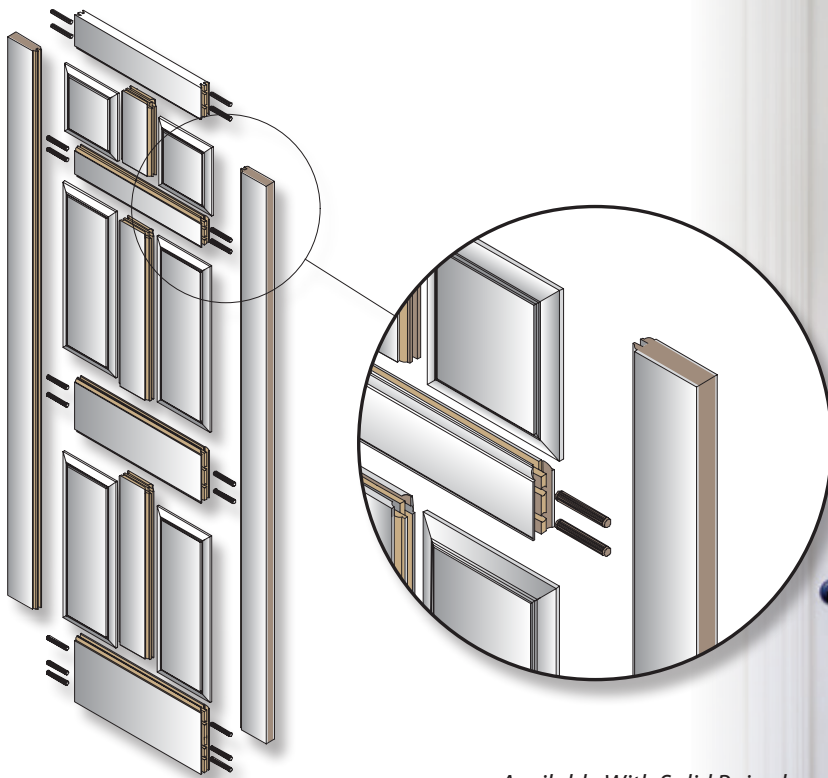

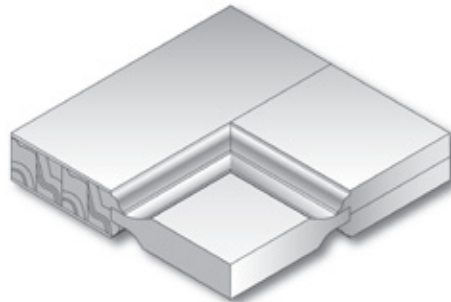

Bravo Raised Panel Ogee Sticking

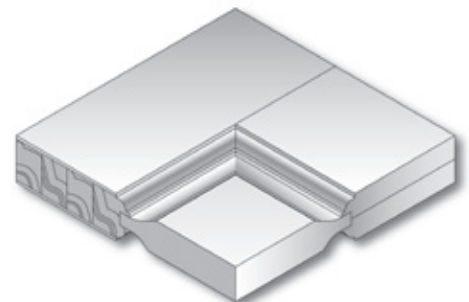

Bravo Raised Panel Ovolo Sticking

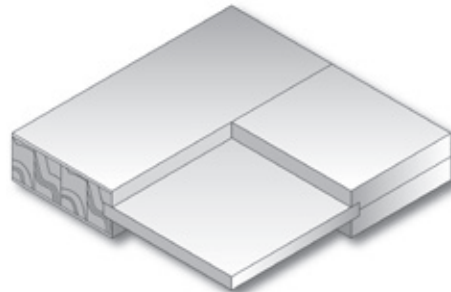

Bravo Flat Panel No Sticking

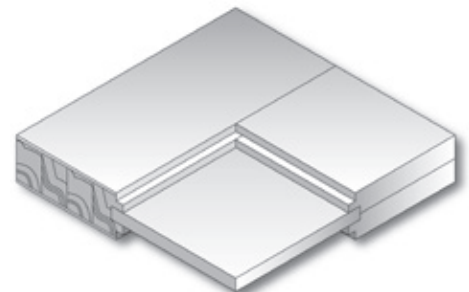

Bravo Flat Panel Square Sticking

**Fire Rating:**

20-minute positive pressure fire ratings available. Maximum size up to 3/0 x 8/0 single. For more detailed fire rating information, visit our website at [www.doormerica.com](http://www.doormerica.com)

*Any combination of panel and sticking options are available.*



# Bravo® Standard Designs

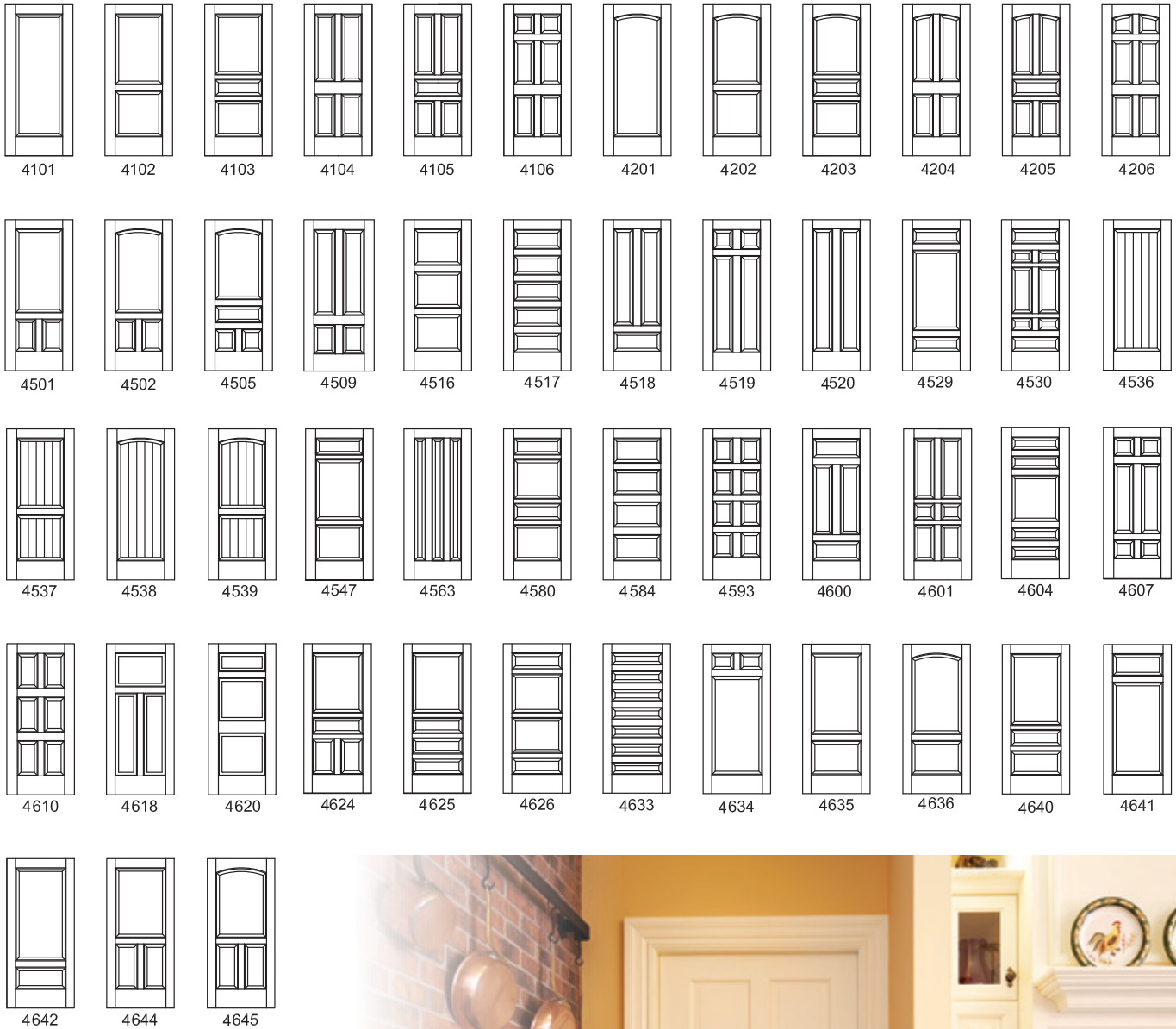

# Specialty Doors



## Textured Glass Doors

One-piece tempered glass available in Obscure, Rain or Reed pattern adds high level of privacy and modern appeal, making them the perfect choice for any interior application.

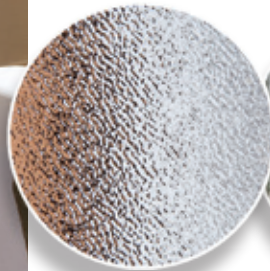

P516 Obscure  
Glass Detail

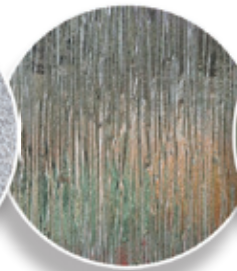

Rain Glass  
Detail

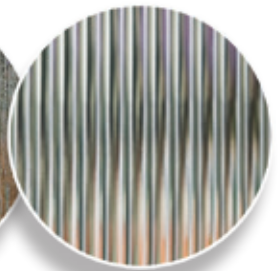

Reed Glass  
Detail

Clear tempered, white laminated, P516 obscure, reed, and rain glass available to replace any square panel in Infinity raised molding or Ovation with your choice of sticking.

[www.doormerica.com](http://www.doormerica.com)

## White Laminated Glass Doors

- White laminated glass is constructed with a PVB plastic interlayer between 2 sheets of glass to form one single, opaque, impact resistant sheet.
- Laminated glass has a sound control rating of STC 34, effectively blocking out unwanted noise.
- Screens out harmful ultraviolet light.
- Reduced risk of shattering or penetration – glass particles cling to vinyl interlayer increasing security and peace of mind.
- Smooth both sides for easy clean up.
- Doors come Factory Primed.

## Mirror Doors

Available in double sided or split design, mirror options are available in Infinity, Ovation and Encore. Perfect for bathrooms, closets and dressing rooms, Infinity door designs on one side can be backed with mirrors that have a raised molding. This same “split design” can be done with Encore router carved doors but with an inset, flush mirror. In Ovation, “split designs” are available with flat panel construction and the mirror can also have a soft arch or eyebrow detail at the top and your choice of sticking. Mirror door option is not available in Bravo.

# Chalkboard Doors & Dry-Erase Doors



The Millennium Collection offers magnetic chalkboard and dry erase options in their Ovation and Encore lines. Just as with Millennium's split door mirror program, now a chalkboard/dry erase can be on one side matched with any of over 140 standard designs or customized to match your project on the other side. These innovative doors are great for kids' rooms, pantries, closets, workshops or family message centers.

Ovation construction allows even more design options by allowing arch or eyebrow panel design on the chalkboard/dry erase side. When coupled with sticking options, such as round, square or no sticking, you have design flexibility in a stile, rail and panel type application.

For a traditional router carved application, chalkboard/dry erase are available in the Encore line. Available in solid core, Encore offers a lighter weight alternative with even more raised panel standard designs available for split construction.

## Louver Doors

Louver doors are available in Infinity with raised moldings and Ovation with a flush louver panel, perfect for bypass, pocket doors and to coordinate with craftsman designs. With their 2" reveal and cassette construction, which can be used in place of any square panel, louver doors can add a "tropical" design element to your project. Optional "true" or "false" louvers allow for air movement or privacy as required per plan.



Open True Louver  
(Infinity shown)



False Louver  
(Ovation shown)





# Barn Doors

Popular barn style and other sliding door applications often require oversize door panel sizes. Millennium Door produces sliding style door panels in hundreds of designs. Available in 7/0 and 8/0 high and up to 4/0 in width. With barn door designs and contemporary styles, Millennium can provide all the options needed for this type of door. Specify doors with an optional wood top rail for top hanging door applications.

**Popular Barn Door Styles:**

*Encore*

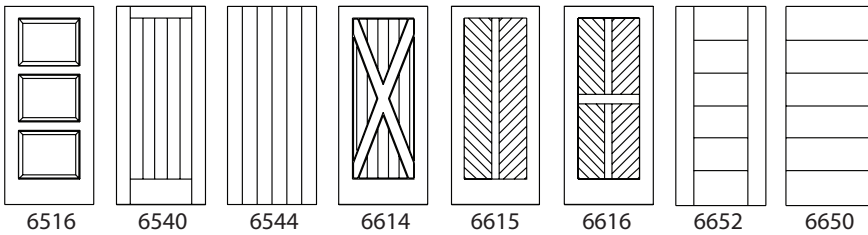

*Ovation*

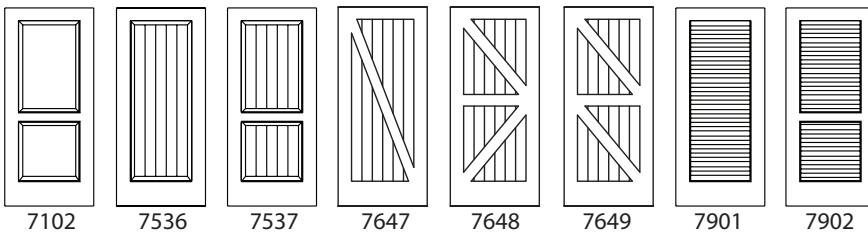

Available in 7/0 and 8/0 heights and 3/6 and 4/0 widths.

[www.doormerica.com](http://www.doormerica.com)





Easy Operation,  
Space Saving!

## BiFold Doors

- Bifold doors are ideal for use in smaller places such as closets, storage areas and laundry rooms
- Infinity raised molding bifold doors have raised molding on the outside and flush molding on the inside for clearance
- Bifold doors come boxed with hardware and top guide track
- Wood top rail and heavy-duty hardware are standard
- 3-1/2" x 3-1/2" -5/8" radius US15 hinges are used on all Millennium bifold doors



**MATCHED PAIRS  
AVAILABLE!**

## Arch Top and Radius Top Doors

Available in Encore, Ovation and Infinity Doors. Arch Top and Radius Top Doors can be manufactured in single or matched-paired applications. Ask for detailed shop drawings for your special opening.

20-minute fire ratings are available on Arch Top Doors only.

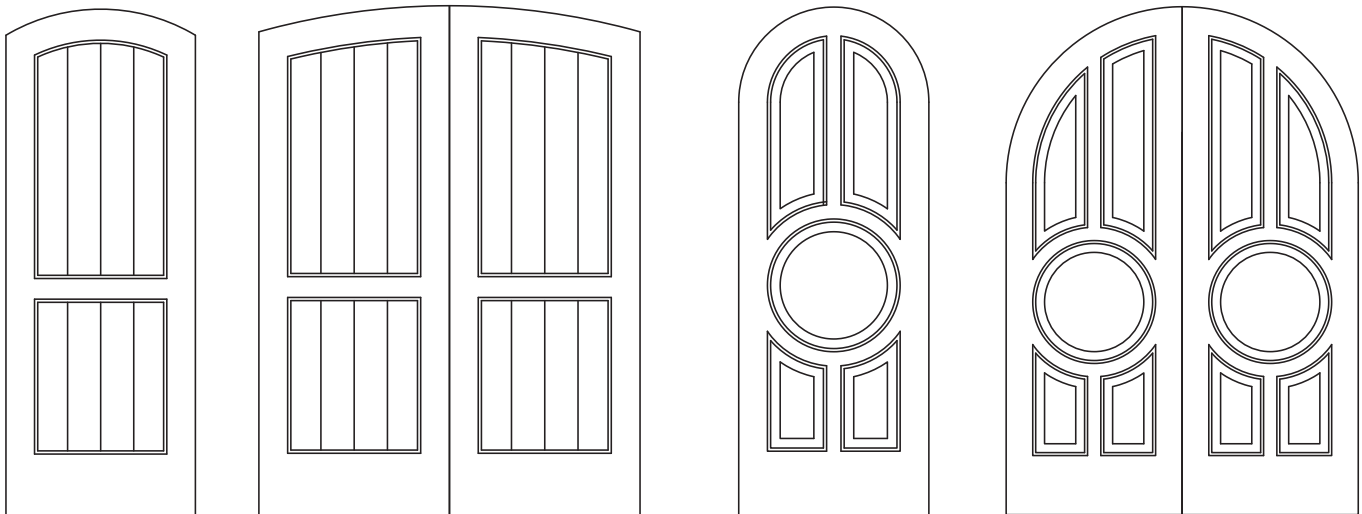

One pillar of a sustainable strategy is the selection of proper building materials.

Sustainable materials such as MDF (medium density fiberboard) are a good environmental choice. The base material of all four Millennium Door lines is MDF, made from the byproducts of the lumber industry.

Because all of our doors are made in the USA, many projects we supply can help earn Regional Manufacturing credits.

We applaud projects designed for sustainability and welcome a chance to contribute. Please send your project specifics and available credits to Millennium Collection group at [www.doormerica.com](http://www.doormerica.com) or call (888) 454-2888.

# Natural, Sustainable, Responsible.

LEED Credit	LEED Criteria	Product Lines - With Special Ordered Materials <i>*Minimum quantities and special lead times will apply</i>						
		Encore PBC Core	Encore Foam Core	Infinity PBC Core	Infinity Mineral Core	Ovation	Intumescent Core	Bravo
<b>MATERIALS &amp; RESOURCES</b>								
MR 4	Recycled Content: 10% Pre-Consumer - 1 point	YES	YES	YES	NO	YES	NO	YES
	Recycled Content: 20% Pre-Consumer - 2 points	YES	YES	YES	NO	YES	NO	YES
MR 5	Regional materials: 10% if within 500 miles - 1 point	YES*	YES*	YES*	YES*	YES*	YES*	YES*
	Regional materials: 20% if within 500 miles - 2 points	YES*	YES*	YES*	YES*	YES*	YES*	YES*
MR 6.0	Rapidly Renewable Materials:	NO	NO	YES	NO	NO	NO	NO
MR 7.0	Certified Wood:	YES	YES	YES	NO	YES	YES	YES
<i>*Location of project determines eligibility. Extracted and Manufactured, Harvested or Recovered within 500 mile radius of project site.</i>								
<b>INDOOR ENVIRONMENTAL QUALITY</b>								
IEQ 4.1	Low Emitting Materials: Adhesives & Sealants	YES**	YES**	YES**	YES**	YES**	YES**	YES**
IEQ 4.2	Low Emitting Materials: Paints & Coatings	YES**	YES**	YES**	YES**	YES**	YES**	YES**
IEQ 4.4	No Added Urea Formaldehyde	YES	YES	YES	YES	YES	YES	YES
<b>INNOVATION IN DESIGN</b>								
ID 2	LEED AP	YES	YES	YES	YES	YES	YES	YES
<i>**IEQ 4.1 &amp; 4.2 applies to adhesives, sealants, paints and coatings applied at project site.</i>								

The LEED (Leadership in Energy and Environmental Design) Green Building Rating System was originally developed by the U.S. Green Building Council (USGBC) to provide a recognized standard for the construction industry to assess the environmental sustainability of building designs.

Millennium Door is committed to engineering our manufacturing processes so that we may assist our customers in achieving their LEED certification rating. The chart above lists all of our product lines and what LEED credits can be earned.

Millennium Door is focused on being a good global partner in environmental stewardship. All Millennium Door products are certified by a nationally recognized third party certification service. Please contact us or visit [www.doormerica.com](http://www.doormerica.com) for further information.

# 90-Minute Fire Rated Doors

Utilizing intumescent technology and our fiberfuse process, the Millennium Collection now offers over 180 standard designs with unlimited customization on 90-minute doors. The 90-minute rated fire door is available in Infinity, Encore, or Ovation.

These doors are available in sizes up to 3/6 x 8/0 1-3/4 for a single and up to 7/0 x 8/0 1-3/4 as a pair. All Millennium Collection doors have fully customizable stile and rail sizes and layouts and are all paint grade, constructed with premium medium density fiberboard (MDF). The 90-minute core of these doors is constructed with layered intumescent and is covered with MDF. The intumescent doors are rated for both category A and category B positive pressure.

This fusion of functionality and design flexibility gives the designer more control than ever before to match the theme of a building while conforming to strict fire code. To see the specifications for the 90-minute door or learn more about many of the other products offered by the Millennium Collection please visit [www.doormerica.com](http://www.doormerica.com) or call (888) 454-2888.



## Infinity<sup>®</sup>

90 MIN. 1-3/4 INFINITY WITH 1-3/8" STANDARD RAISED MOLDING

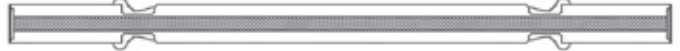

90 MIN. 1-3/4 INFINITY WITH 1-3/8" STANDARD FLUSH MOLDING



## Encore<sup>®</sup>

90 MIN. 1-3/4 ENCORE WITH 1-3/8" STANDARD PROFILE



90 MIN. 1-3/4 ENCORE WITH 1-3/8" OGEE PROFILE



## Ovation<sup>®</sup>

90 MIN. 1-3/4 OVATION FLAT PANEL NO STICKING



90 MIN. 1-3/4 OVATION FLAT PANEL SQUARE STICKING



90 MIN. 1-3/4 OVATION FLAT PANEL 1/4 ROUND STICKING



90 MIN. 1-3/4 OVATION FLAT PANEL OGEE STICKING



*Bravo doors are not available with 45-90 minute fire rating.*





# Warranty

## WARRANTY PERIOD:

TYPE	INTERIOR	EXTERIOR	SPECIALTY PRODUCTS
INFINITY	LIMITED LIFETIME	1 YEAR*	VARIES WITH PRODUCT
OVATION	LIMITED LIFETIME	N/A	
ENCORE	LIMITED LIFETIME	N/A	VARIES WITH PRODUCT
BRAVO	LIMITED LIFETIME	N/A	VARIES WITH PRODUCT

\*Only when exterior sealant is applied by ABS-Mfg and on non-intumescent core doors.

## SPECIALTY PRODUCTS:

SPECIALTY GLASS	10 YEARS DOOR	N/A	1 YEAR SPECIALTY GLASS
MIRROR	10 YEARS DOOR	N/A	1 YEAR MIRROR
LOUVER	10 YEARS DOOR	N/A	N/A
CHALKBOARD	10 YEARS DOOR	N/A	1 YEAR CHALKBOARD
DRY ERASE	10 YEARS DOOR	N/A	1 YEAR DRY ERASE
BIFOLD DOORS	10 YEARS DOOR	N/A	1 YEAR
ARCHED/RADIUS	10 YEARS DOOR	N/A	

## Limited Lifetime Warranty:

Warranty applies to the original private residential home-owner in single-family home applications and is non-transferable.

## Warranty Disclaimer:

Should any door manufactured by American Building Supply fail to conform to this published warranty, American Building Supply will repair or replace the door. If repair or replacement is not practical, American Building Supply will refund the full purchase price of the door. The warranty does not cover refinishing, rehanging or any other cost related to the repair, replacement, or refund. The manufacturer will not be liable for any door(s) repaired or replaced without its prior written consent. The purchaser, upon receipt of the doors, should inspect each door. The purchaser must give written notice of any claim to American Building Supply within 15 days after receipt of doors. American Building Supply must be given a reasonable opportunity to investigate the reported defect before corrective action has begun.

## This warranty is subject to the following tolerances:

1. Size tolerance: thickness  $\pm 1/16"$ , length  $\pm 1/16"$ , width  $\pm 1/16"$ , prefit width  $\pm 1/16"$ .
2. Squareness tolerance diagonal measurement difference will not exceed  $1/8"$ .
3. Factory hardware preparation tolerance  $\pm 1/32"$  on hinge preparation and lock preparation cutouts.
4. Warp will not be considered a defect unless it exceeds  $1/4"$  in the plane of the door itself. For doors  $1-3/4"$  or thicker, warp will not exceed  $1/4"$  in doors  $3/6 \times 7/0$  or smaller, nor will it exceed  $1/4"$  in any  $3/6 \times 7/0$  section of larger doors. For doors less than  $1-3/4"$  thick, warp will not exceed  $1/4"$  in doors  $3/0 \times 7/0$  or smaller. Warp is measured by placing a straight edge on the concave face and determining the maximum distance from straight edge to door face.
5. Louver door blade warp tolerance is not to exceed  $1/4"$  between blades.
6. Pre-hung jamb warp tolerance is not to exceed  $1/4"$ .

## This warranty is subject to the following storage and handling instructions:

1. Doors shall always be stored flat and in clean, dry surroundings protected from dirt, water, and abuse. If stored for a long period of time, the doors must be sealed on all six sides with a high quality primer sealer. Never store doors directly on concrete and allow spacing for proper ventilation.
2. Doors must not be exposed to excessive amounts of moisture, heat or direct sunlight.
3. Doors must always be handled with clean hands or clean gloves.
4. Doors must always be lifted and carried, do not slide or drag across one another.

## This warranty is subject to the following finishing instructions:

1. Interior primed doors should be finished in accordance with the published American Building Supply care and finishing instructions for primed interior doors.
2. Exterior primed doors (Infinity only) should be finished in accordance with the published American Building Supply care and finishing instructions for primed exterior doors and must be installed in a location completely protected from the elements. Doors must be ordered with exterior sealant.

## Warranty limitations and exclusions:

1. Exterior doors in locations without adequate overhang protection from the elements, or hung in pairs (Infinity only).
2. Doors painted dark colors without protection from the elements.
3. Exterior doors without exterior sealant applied by ABS-Mfg, door thicknesses less than  $1-3/4"$ .
4. The natural variations or unsatisfactory results in color, texture, gloss level, or appearance resulting from the field application of paint or any other finishing material.
5. Warp not exceeding  $1/4"$  in the plane of the door itself. Warp shall include bow, cup and twist. For doors larger than  $3/0 \times 7/0$ , warp not exceeding  $3/8"$  in the plane of the door itself. Warp for  $3/8"$  flat panel door over  $3/0$  wide.
6. Doors left unfinished at the job site and exposed to the sun or excessive cold, heat, or moisture.
7. Radius top doors for warp or exterior applications.
8. Doors with design one side / flush slab one side.
9. Glass or Mirror – breakage once doors have been received.
10. Failure to drill pilot holes for all hardware attachment screws.
11. Failure to follow Care & Finishing, Installation, and Maintenance Instructions.
12. Specialty doors, such as Glass, Louver, Mirror, Marking Board when used in exterior applications.
13. Failure to install pre-hung jambs and doors per Installation Instructions. Including, but not limited to, improper handling and on-site storage per Care & Finishing.
14. Cutting doors more than  $1"$  in height and/or more than a total of  $1/4"$  in width.
15. Damage beyond the control of American Building Supply, Inc., including but not limited to, mishandling, shipping caused breakage, cracking or scratching; normal wear and tear, customer misuse, abuse, neglect or alteration; acts of nature including, but not limited to, fires, floods, earthquakes, wind, etc.
16. Barn door application

There are no warranties that extend beyond the foregoing, and the manufacturer's responsibility under this warranty is as stated herein. No dealer, distributor or person other than the manufacturer has the right to alter this warrant verbally or in writing. The manufacturer shall not be liable for consequential, indirect or incidental damage, or for any amount in excess of the manufacturer's price for the doors involved, whether the claim is for breach of warranty or negligence.

In order to provide our customers with the finest products, manufactured in the most up-to-date manner, American Building Supply reserves the right to make design or specific construction changes without notice.

**Care & Finishing Instructions (WDMA Recommendations):**

1. Acclimatize - Prior to painting, insure that the building atmosphere is dried to a normal interior relative humidity and temperature. Insure that the doors have been allowed to equalize to stable moisture content.
2. Storage - Doors should always be stored flat and in a clean dry surrounding with spacing to allow for proper ventilation. Doors should not be stored directly on concrete or leaned against walls.
3. Preparation - Doors should not be considered ready for painting when initially received. Prior to painting, remove all handling marks, raised grain, and other undesirable blemishes by completely block sanding all surfaces with 180-220 grit sand paper or fine sanding sponges and spot prime as needed. Be sure not to sand through the factory primer.
4. Seal Door - All exposed surfaces must be sealed, including the top and bottom rails. Cut outs for hardware in doors must be sealed prior to installation of hardware.
5. Between Coats - Insure that the door surfaces being painted are satisfactory in both smoothness and color before applying the next coat. Sand if necessary and be sure that each coat is hard and dry before applying the next coat.
6. Paint Selection - On factory primed doors, a waterborne all acrylic latex finish is most compatible with the primers used and is highly recommended. Always obtain and follow paint manufacturers recommendations. Never attempt to paint in high moisture conditions, for the paint will not dry quickly enough and will penetrate into the door and can cause expansion and surface irregularities such as fiber raise.
7. Exterior Application - When painting exterior doors (Infinity only), two coats of high quality exterior sealer or primer must be used. Top and bottom rails, edges, faces, hardware cutouts, light and louver cutouts must be sealed prior to finish painting. This must be done as soon as the doors arrive at the job site. To prevent warping, avoid dark colors and have adequate overhang to protect the doors from the elements. Infinity doors must be ordered with exterior sealant applied at factory or warranty will be voided.
8. Painting - Apply a minimum of two coats of high-grade latex or enamel appropriate for the application to all six sides. During paint application process doors should be stood straight up or hanging. Do not lean doors or lay doors down without equal support throughout the door to avoid warpage. Insure that the environment that the doors are painted in is dry and at a temperature recommended by paint manufacturer.
9. Test Door - Always only paint ONE door to assure quality first before continuing on. ABS-Mfg must be contacted immediately if any quality issues are noticed.

**Maintenance:**

1. Most finishes on exterior doors deteriorate relatively quickly. Inspect the condition of exterior finishes at least once a year and refinish as often as needed to maintain the protective integrity of the finish.
2. Insure that the doors continue to swing freely and that all hardware remains functional.

**Installation:**

1. The utility or structural strength of the doors must not be impaired in fitting to the opening, in applying hardware, in preparing for lites, louvers, plant-ons or any other detailing.
2. Use two hinges for door up to 60" in height, three hinges for doors up to 90" in height and an additional hinge for every additional 30" of door height or portion there of. Use heavy weight hinges on doors over 175 pounds. For special 90 minute rated doors special hinge applications apply due to excessive door weight.

3. Clearance between door edges and door frame should be a minimum of 1/16" on hinge edge. For latch edge and top rail the clearance should be 1/8".
4. All hardware locations, preparations for hardware and methods of hardware attachment must be appropriate for the specific door construction. Templates for specific hardware preparation are available from hardware manufacturers or their distributors.
5. When lite or louver cutouts are made for exterior doors, they must be protected in order to prevent water from entering the door core. Metal flashing on cutouts is required.
6. Pilot holes must be drilled for all screws that act as hardware attachments. Threaded to head screws, are preferable for fastening hardware to non rated doors and are required on all fire rated doors.
7. In fitting for height, do not trim top or bottom edge more than 3/4" unless accommodated by addition blocking. Never trim the top edge of a fire rated door.
8. Doors and door frames must be installed plumb, square and level.
9. When installed in exterior applications, doors must be properly sealed and adequately protected from the elements. Flashing should be applied at head, jambs and seal.
10. For installation of any fire rated door see "Fire Door Installation - see #12 below".
11. **Fire door installation:**  
NFPA 80, Fire doors and Windows, 1995 Edition, requires that all fire doors and frames be prepared under an inspection service.
  - 11.1 All components of an opening must have a certification label or certification mark to identify as a fire rated component. This identification MUST be applied at the point of manufacture or at an authorized machining distributor. FIELD LABELING OF ANY COMPONENT BY ANYONE OTHER THAN THE INSPECTION AGENCY SHALL VOID THE LABEL.
  - 11.2 The lowest rating of any component determines the rating for the total assembly. (I.e. if a 1 hour door is installed in a 20 minute frame, the maximum rating for the total assembly would be 20 minutes.)
  - 11.3 The clearance between the door and the frame and between meeting edges of doors swinging in pairs shall not exceed 1/8 inch. The clearance under the bottom of the door shall be as follows. Any trimming for height may be done on the bottom rail only (per NFPA 80, maximum trim of 3/4" - 19.0mm allowed on site.
    - 11.3.1 The clearance between the bottom of the door and a raised noncombustible sill shall not exceed 3/8".
    - 11.3.2 Where there is no sill, the clearance between the bottom of the door and the floor shall not exceed 3/4".
    - 11.3.3 The clearance between the bottom of the door and the rigid floor tile shall not exceed 5/8".
    - 11.3.4 The clearance between the bottom of the door and the nominal surface of floor covering shall not exceed 1/2".
  - 11.4 Job site modification is restricted to the following.
    - 11.4.1 Function holes for mortise locks, and mounting holes for hardware not to exceed 1" in diameter.
    - 11.4.2 Holes for labeled viewers.
    - 11.4.3 Protection plates and preparation of surface mounted hardware.
    - 11.4.4 **A maximum of 3/4" undercutting of BOOK HEIGHT on particle board and mineral core doors.**
    - 11.4.5 Pilot holes MUST be drilled for all screw applications.
  - 11.5 Fire doors, with wood, particleboard, or mineral core are manufactured with the same size top and bottom rails, so that either end of the door can be the top. If there is an exception, the rails will be identified, and the top of the door must not be trimmed.

# Care & Finishing and Installation

- 11.6 Positive pressure assemblies require the following.
- 11.6.1 To qualify for smoke and draft assemblies (PER UBC STD 7-2 1997) the doors must have the secondary "S" label and be installed with listed gasketing that meets (UBC STD 7-2 1997 Part 2) for 20 Minute only.
  - 11.6.2 Approved intumescent smoke seals must be applied to the sides and top of the frame, and to the meeting edge of the inactive leaf of doors hung in pairs for Category B. When Category A doors are used, intumescent gasketing is not required.
  - 11.6.3 See installation instructions provided with the approved intumescent smoke seals, which are used.
- 11.7 Latch sets must have a minimum throw of 1/2" NFPA 80 Table 2-8.2.3 states that the latch throw for pairs must be 3/4". The minimum latch throw is stated on the certification label.
- 11.8 Hinges to be installed per NFPA 80 Table 2-8.1.1. Two hinges are required for a 60" high door and one additional hinge is required for each additional 30" or fraction thereof. The size and thickness of the hinges are covered in the table.
- 11.9 Closers attached to mineral composite or particleboard core doors usually must be through bolted. An exception to this would be when the doors have interior blocking that would permit the closures to be attached with screws.
- 11.10 When vision lights are installed in a fire door, the cutout must be done at the manufacturing facility or machining facility. Cutting the door for lights in the field is not allowed unless the preparation is performed under an inspection and a labeling program. Only certified fire rated glass, which is installed in approved frame shall be used. Only glazing labeled for fire may be used, and must be installed in accordance with their individual listing.
- 11.11 Fire doors equipped with automatic louvers shall be used only for protecting openings in required enclosures when the opening is not in a means of egress or otherwise located so that products of combustion flowing through the opening could jeopardize the use of exits prior to the operation of the louver. 20 minute fire rated doors are not permitted to have louvers.
- 11.12 Wrap around steel edges with an astragal must be applied to meeting edges of pairs, unless the certification label specifically states that they are not needed. 20 minute doors can usually be installed in pairs with metal steel meeting edges without an astragal. Steel meeting edges should be 18 or 20 gauge, with a minimum lap of 1". Attachment should be with 3/4" No. 8 screws, 12" on center. Mortise edge guards are not allowed unless included in the individual listing. When intumescent meeting edges are used, metal edges are not required.
- 11.13 Certification labels are attached at the point of manufacturer or under an inspection service and MUST NOT be removed or replaced except by authorized representatives of the inspection agency. Labels will be applied on the hinge stile at eye level.
- 11.14 Intumescent Layered Core 45, 60 & 90 fire doors use requires the following additions and exclusions of above sections:
- 11.14.1 **Intumescent core fire doors MUST be manufactured to net size, no undercutting is allowed. This exception modifies 11.4.4 above.**
  - 11.14.2 It is mandatory that hinges be installed per these instructions. 6/8 and 7/0 in height must be installed with three minimum and doors over 7/0 in height must have four minimum. Hinges must be 4-1/2" x 4-1/2" heavy weight, .180 depth, and 2" x #12 wood screws used. All 45, 60 & 90 minute Intumescent layered core doors will have hinge screw pilot holes drilled at the factory.
  - 11.14.3 Millennium 45, 60 & 90 minute (Intumescent layered core) doors are heavy. Please take the proper precautions when installing these doors. Extra help and care should be given due to the weight of the door.

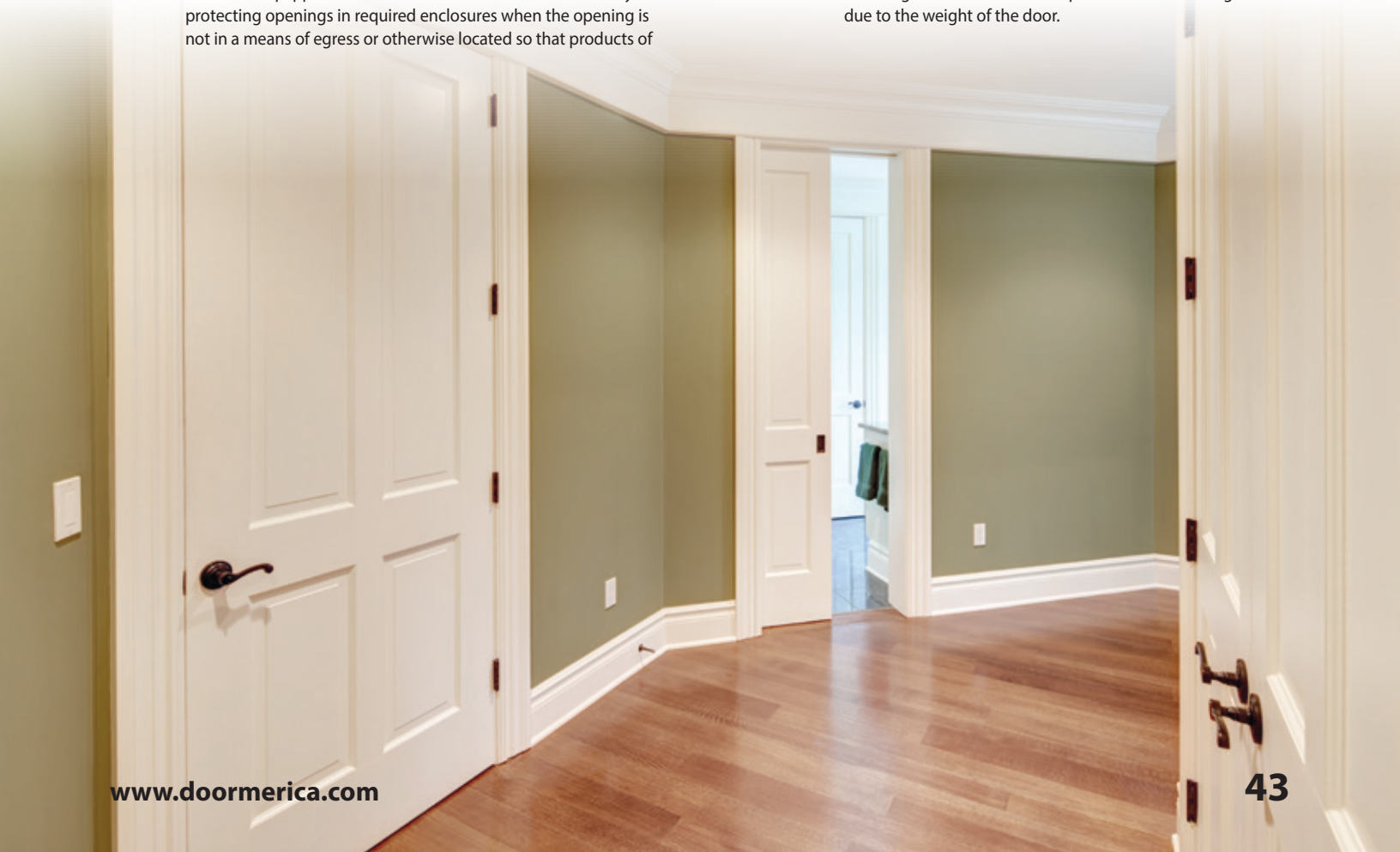

*Encore*<sup>®</sup>

Router Carved Doors

*Ovation*<sup>®</sup>

Layered Panel Doors

*Infinity*<sup>®</sup>

Inlaid Molding Doors

*Bravo*<sup>®</sup>

Traditional Stile & Rail Doors

Traditionally  
Modern