







TM6100 barn doors in Select Alder with Espresso stain and White Lami glass



## Table of Contents

TruStile® Overview . . . . .	2
Authentic Designs® . . . . .	11
Quality and Construction . . . . .	62
Material Options . . . . .	68
Design Options . . . . .	80
Commercial Applications . . . . .	90
Door Collections . . . . .	101



T H E D E F I N I T I O N O F L U X U R Y

TM6100 in White Oak with Shagreen Grey Oyster leather and One Step (OS) sticking

## Premium Architectural Doors

There was a time when doors were appreciated for their architectural value, gracing the openings of homes and embodying the principles of their design periods.

At TruStile, we miss those days. We are committed to partnering with architects, home builders and homeowners, to revive the rich tradition of building high-quality, architecturally-correct doors with a range of customization options to fit your preferences and your home's unique character.

**HANDCRAFTED  
AND  
CUSTOM MADE**

Our team of craftsmen, designers and machinists ensure only the best doors leave our shop.



# Visualize the TruStile Difference

BEFORE

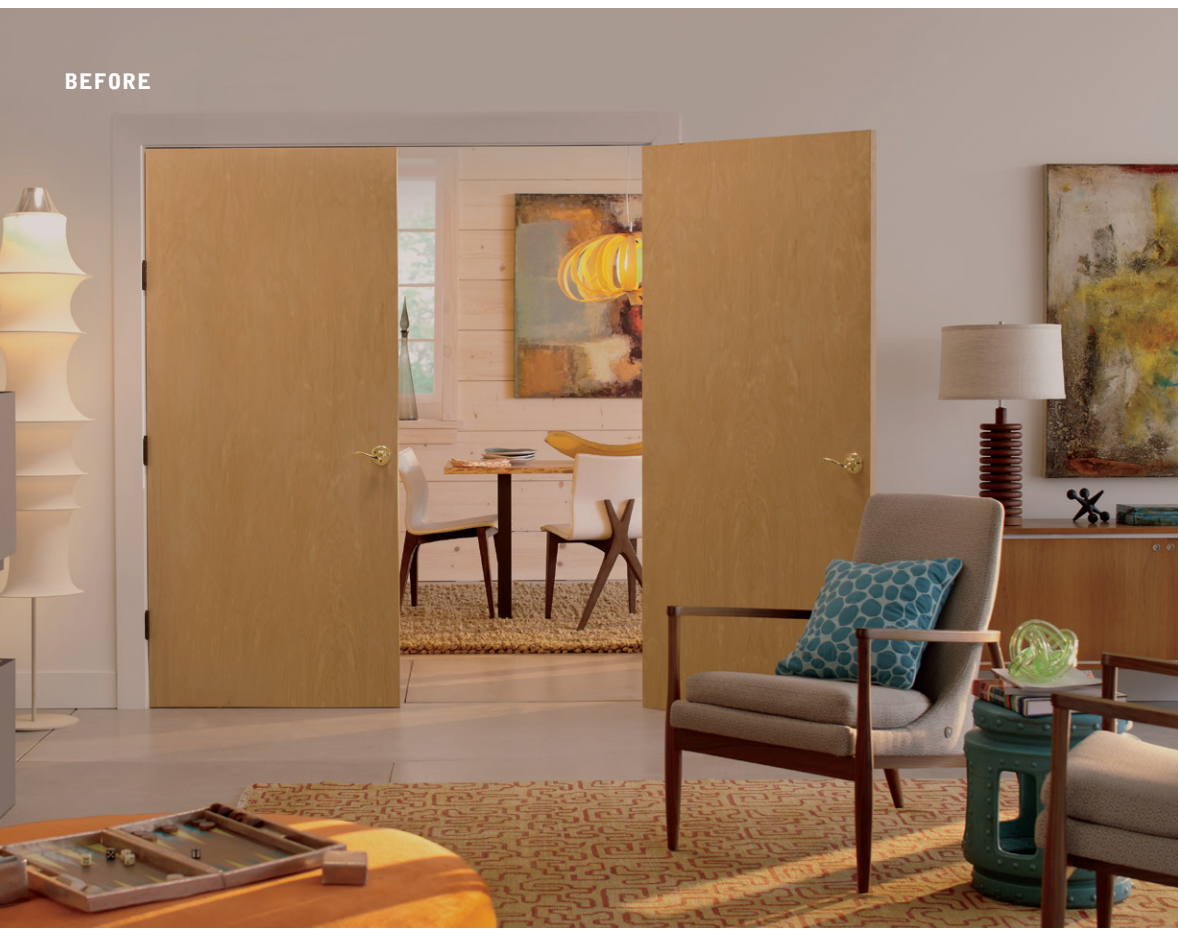

All too often, doors are an overlooked design element — even in high-end custom homes that include an otherwise impressive selection of amenities and upgrades.

Other manufacturers have focused on value-engineering doors, thus diminishing their structural and design integrity. However, the visual impact of high quality architectural doors is dramatic.

AFTER

TM13000 in Cherry with Kerf Cut reveal



# The Architecturally Correct Door

TruStile doors are made with authentic stile and rail construction. We wouldn't think of routing or stamping a door. Each TruStile door is made to order with perfectly proportioned components, created individually to ensure that every door is architecturally correct, regardless of size.

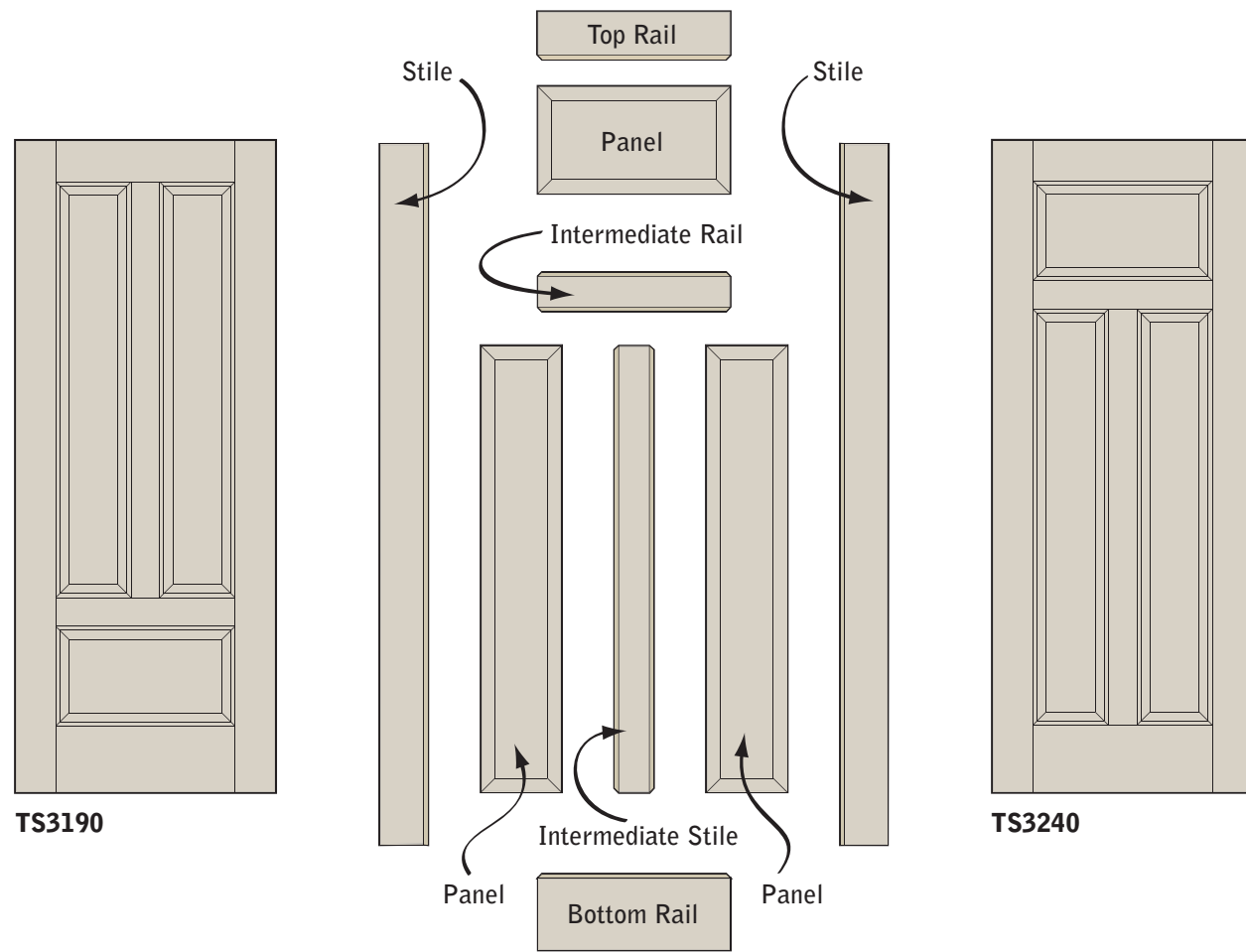

## All doors are not created equal.

The figure illustrates the timeless advantage of TruStile's authentic stile and rail construction. All door components can be customized and combined to create the style you desire, while the construction method gives each door crisp, architecturally-correct lines.



TS3240 in Cherry with Square Stick (SS) sticking and Flat (C) panel



# 6 Steps to Designing Your Perfect Door

## TruStile Selection Guide

To guide your style choices, consider the recommendations in the Authentic Designs section on page 11.



### 1

#### DOOR STYLE

Choose from over 400 door styles to match your home's architecture.



### 2

#### WOOD SPECIES

Select MDF for painted applications or choose from 20 wood species.

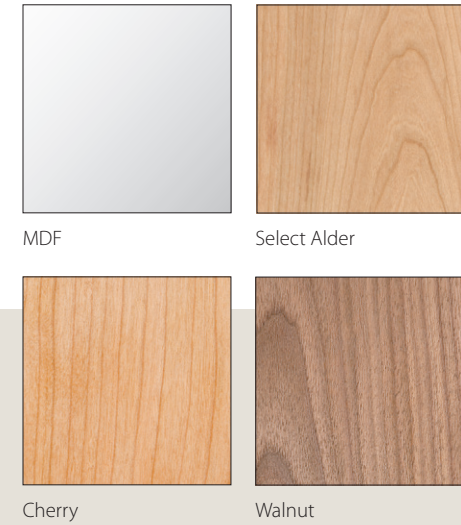

### 3

#### PROFILE OPTIONS

Refine your design with the widest selection of profile options to match your desired style.



Roman Ogee (OG) moulding with Raised (A) panel



Square Stick (SS) sticking with V-groove panel



Bolection (BM) moulding with Senior Raised (E) panel

### 4

#### MATERIAL INSERTS

Consider exchanging a panel for a unique material insert — glass, resin, leather or metal.

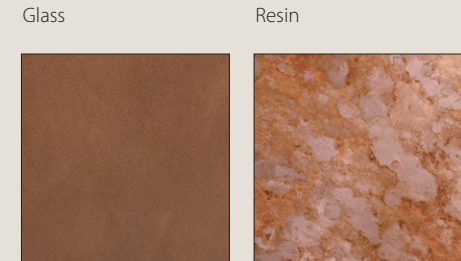
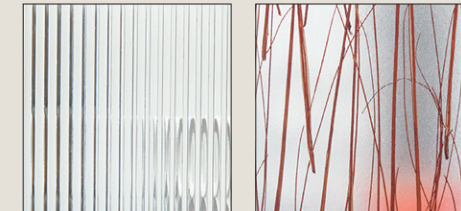

### 5

#### DESIGN OPTIONS

Further customize your doors with design options such as Built-in mirrors or Common Arch Pairs. See page 80 for more ideas.

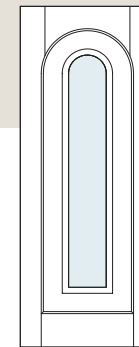

### 6

#### CUSTOM DIMENSIONS

Further customize your door design by changing the stile and rail dimensions.







## Authentic Designs®

Where do you begin to choose the right door design for your home? TruStile's Authentic Designs makes the selection process fun and easy.

With a range of materials and options for 12 popular architectural styles, TruStile provides the widest range of on the market today.

Read on and be inspired with just a few of our tantalizing options for distinctive, remarkable doors.

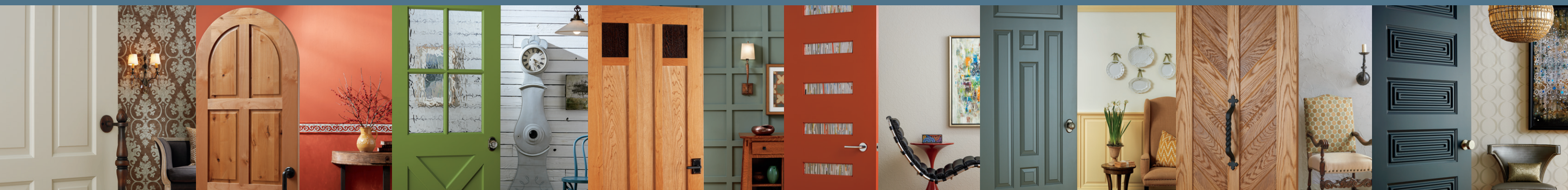





# ART DECO

An eclectic style decorated with geometric shapes and accents of metal and glass.



TMB6120 in MDF with Bevel profile

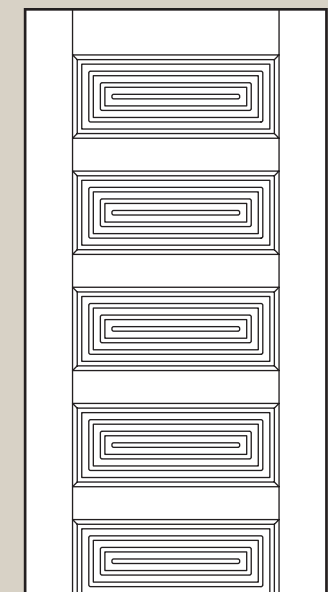

- The Art Deco design style began after WWI and flourished in the 1930s and 1940s, waning after WWII.
- While there are no distinct guiding design principles of Art Deco, there are stylistic elements connected by common themes: the decorative, the commercial, the fashionable and the symbolic.
- The TruStile Art Deco door styles combine modern European design ideas introduced in France with the romance of 1930s Hollywood.



ART DECO  
INTERNATIONAL STYLE  
ART MODERNE  
ART NOUVEAU

Find the ideal expression of the streamlined and sophisticated art deco style right here.

PROFILE SUGGESTIONS



Square Stick (SS) sticking with Flat (C) panel



Bolection (BM) Moulding with Raised (A) panel



Half-round Tambour profile

WOOD SPECIES SUGGESTIONS



MDF/Paint Grade

Mahogany



White Maple

Wenge

INSERT SUGGESTIONS

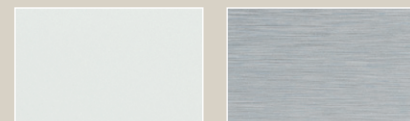

White Lami glass

Brushed Aluminum metal

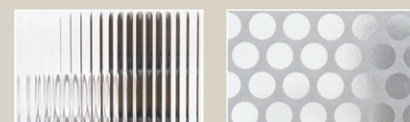

Reeded glass

Cirque resin

RECOMMENDED DOOR STYLES

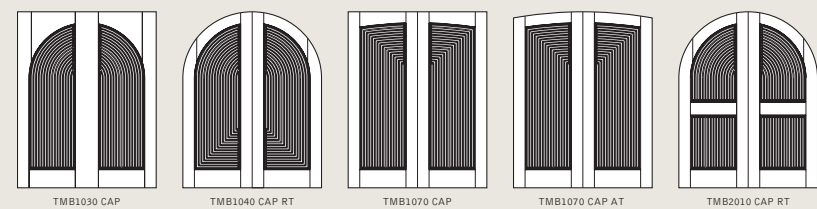
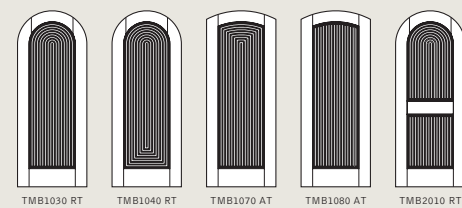
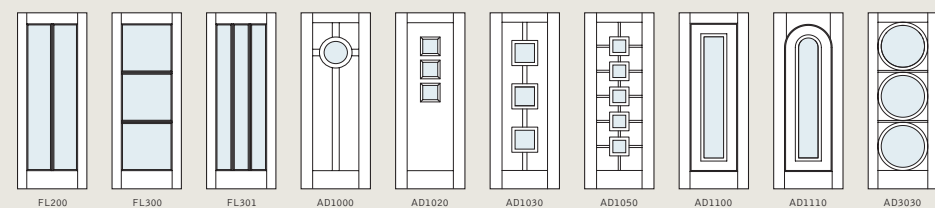
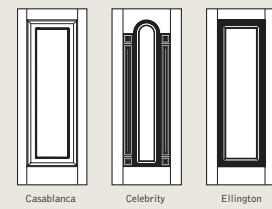
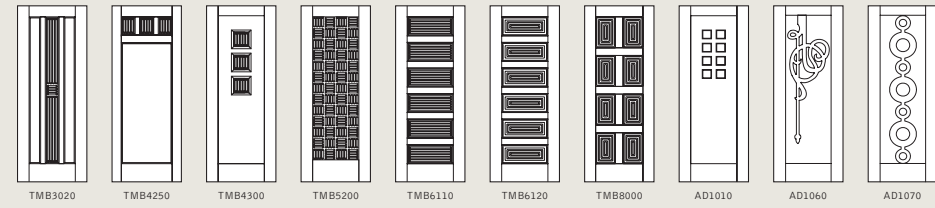
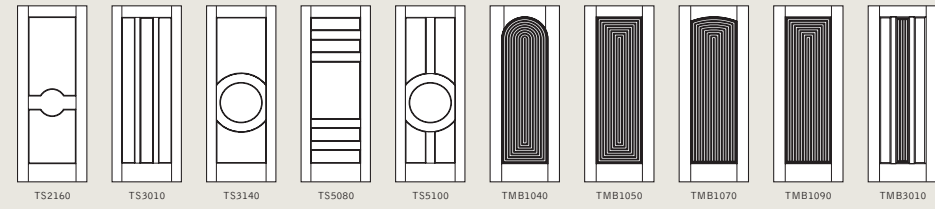

AD1070 in MDF





TS7010 in MDF with Roman Ogee (OG) sticking and Raised (A) panel

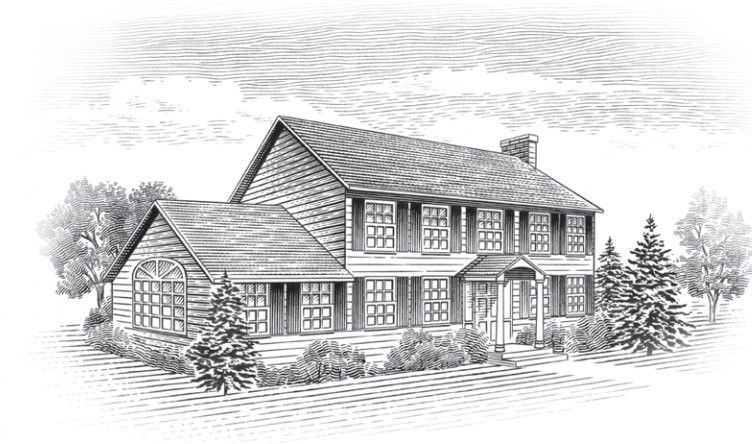

## COLONIAL

An authentically American style characterized by stately, historic design features.

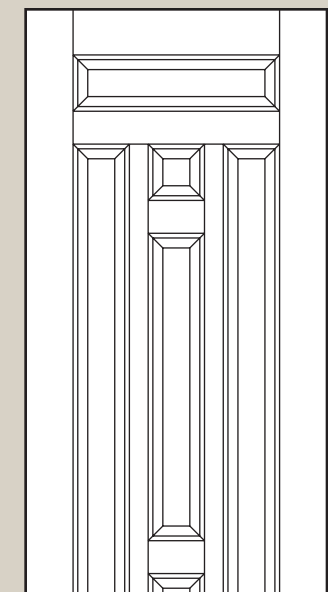

- A variety of architectural styles developed throughout the 18th and 19th centuries as the English, Dutch, Germans and French settled in America.
- Characterized by symmetry and balance, formal surface design and ornamentation with special attention to doors and windows.
- Authentic TruStile doors from the Colonial collection provide classic grace and elegance along with an early American sensibility.



COLONIAL  
 GEORGIAN  
 FEDERAL  
 GREEK REVIVAL

Find the distinct, formal design for your colonial home that emphasizes symmetry and balance right here.

PROFILE SUGGESTIONS



Roman Ogee (OG) sticking with Scoop (B) panel



Cove & Bead (CB) sticking with Scoop (B) panel



Quarter Bead (QB) sticking with Raised (A) panel

WOOD SPECIES SUGGESTIONS



MDF/Paint Grade

Cherry



Mahogany

Walnut

INSERT SUGGESTIONS



Bevel glass

Seedy Wash glass

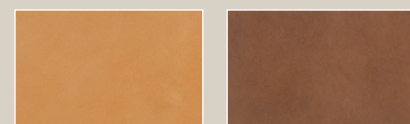

Oak leather

Pampas leather

RECOMMENDED DOOR STYLES

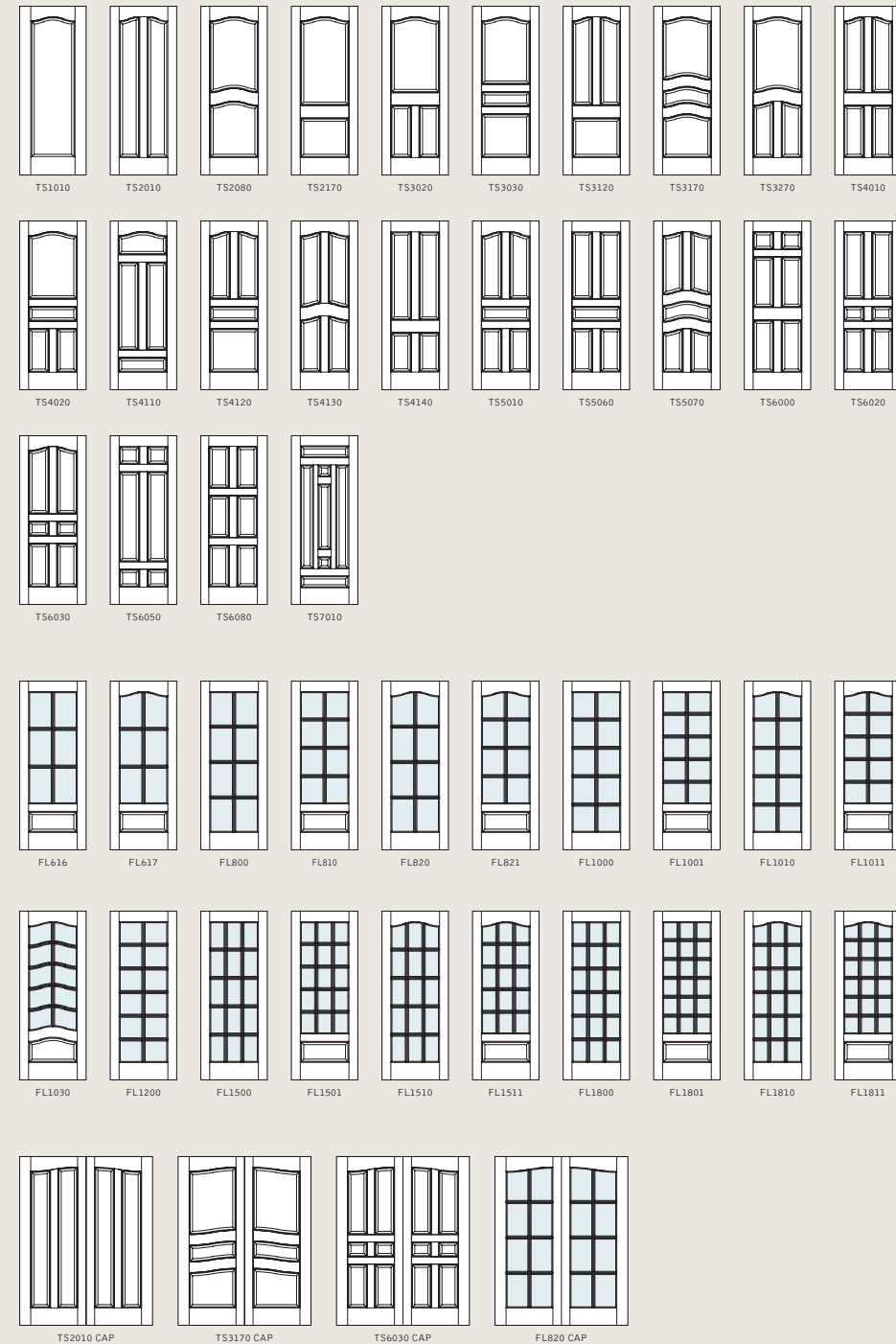

TS4010 in Walnut with Roman Ogee (OG) sticking and Scoop (B) panel





AD1030 in LVL with Square Stick (SS) sticking, Flat (C) panel and Ginkgo Thatch resin

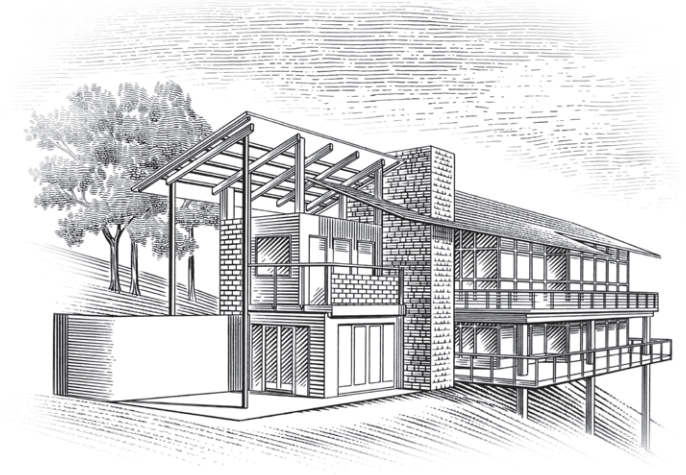

# CONTEMPORARY

A forward-looking style that is uniquely yours.

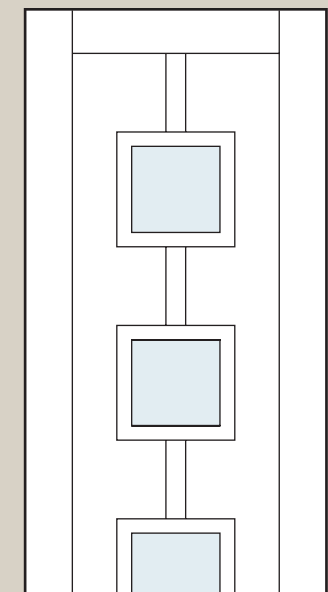

- Contemporary architecture is the current building style of today.
- Characteristics of contemporary homes are unique or odd shaped frames, open floor plans, oversized windows, connected indoor and outdoor spaces and warm interiors.
- TruStile's Contemporary series is an eclectic collection that borrows ideas from different eras. Popular elements are clean lines and the use of natural, sustainable materials.



CONTEMPORARY  
INDUSTRIAL  
TODAY'S STYLE

Find the ideal expression of what  
contemporary design means to you.

PROFILE SUGGESTIONS



1/8" Radius reveal



Roman Ogee (OG) sticking  
with Raised (A) panel

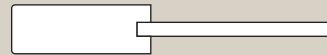

Square Stick (SS) sticking  
with Flat (C) panel

WOOD SPECIES SUGGESTIONS



MDF/Paint Grade

Walnut



LVL

Bamboo

INSERT SUGGESTIONS



Brushed Brass metal

Ginkgo Thatch resin

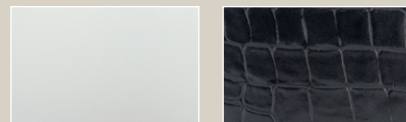

White Lami glass

Croc Black leather

RECOMMENDED DOOR STYLES



TM9000 in MDF with  
1/4" Kerf Cut reveal





PL404 in MDF with Wave glass, Roman Ogee (OG) sticking and Flat (C) panel

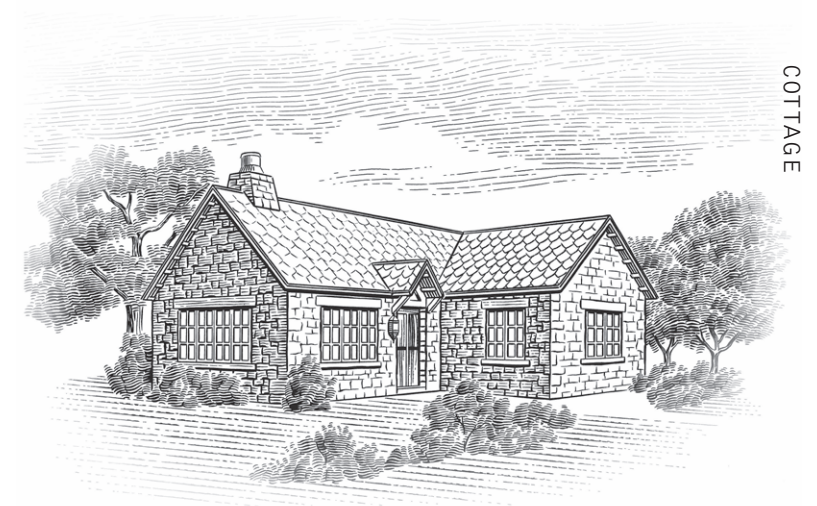

## COTTAGE

A comfortable style that reflects architectural simplicity.

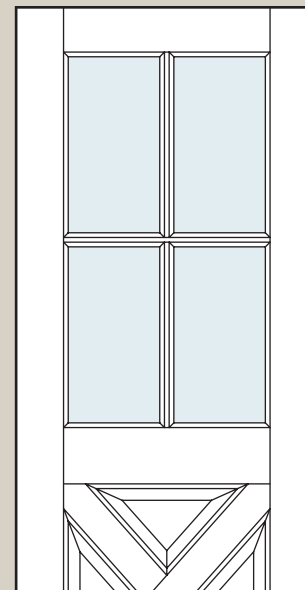

- The American cottage style of architecture was inspired by the English countryside and features a cozy, almost storybook character.
- Characteristics include steep roofs, arched doors and casement windows. A variety of natural materials can be used ranging from wood siding, stone, shingles and copper.
- TruStile's Cottage series represents historically accurate door styles in both panel and glass configurations, as well as updated interpretations of the historic designs.



Find the natural expression of the simple  
and charming cottage style right here.

PROFILE SUGGESTIONS

Quarter Bead (QB) sticking  
with Flat (C) panel

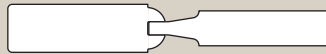

Quarter Round (QR) sticking  
with Raised (A) panel

WOOD SPECIES SUGGESTIONS

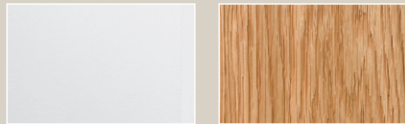

MDF/Paint Grade

White Oak Wirebrush



Select Alder

Douglas Fir

INSERT SUGGESTIONS



Arctic glass

Clear Leaf glass

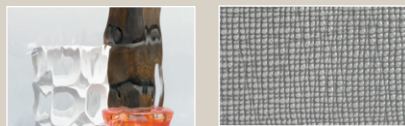

Wave glass

Wagon Lit Sonic  
leather

RECOMMENDED DOOR STYLES



TS3100 in MDF with Quarter Bead  
(QB) sticking and Flat (C) panel





TS5120 in Cherry with Wenge Insert, Square Stick (SS) sticking and Flat (C) panel



# CRAFTSMAN

A simple style focused on natural materials and an attention to period details.

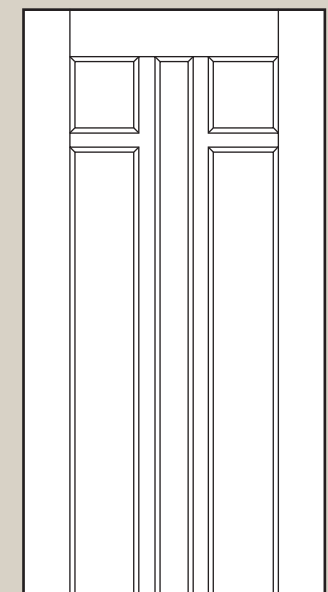

- The American Craftsman style emerged from the English Arts & Crafts movement of the late 1800s and was a reaction to the overly decorative Victorian era.
- Emphasizes simplicity of form, originality and local natural materials.
- Simplicity and quality workmanship define the TruStile Craftsman door collection.



CRAFTSMAN  
ARTS & CRAFTS  
BUNGALOW  
PRAIRIE SCHOOL

Find hand-crafted doors that will add an authentic touch to your modern-day bungalow right here.

PROFILE SUGGESTIONS



Square Stick (SS) sticking with Flat (C) panel



One Step (OS) sticking with Flat (C) panel

WOOD SPECIES SUGGESTIONS

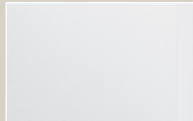

MDF/Paint Grade



Cherry



Douglas Fir



Quarter Sawn White Oak

INSERT SUGGESTIONS



Glue Chip glass



Seedy Wash glass



Reptilian metal

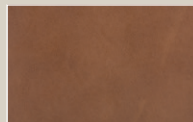

Pampas leather

RECOMMENDED DOOR STYLES



TS3300 in MDF with Square Stick sticking and Flat (C) panel







Arch-top modified TS3040 in MDF with Roman Ogee (OG) sticking and Senior Raised (E) panel



FRENCH COUNTRY

# FRENCH COUNTRY

An eclectic yet decidedly French style that evokes classic European appeal.

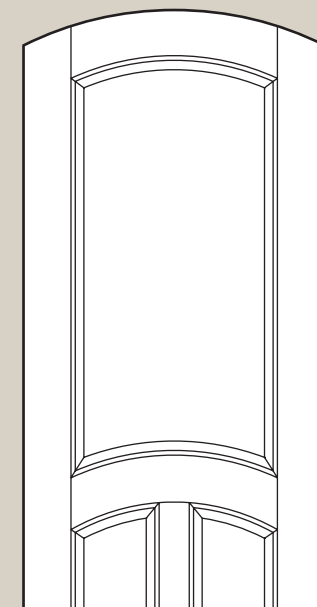

- From elaborate Ecole-des-Beaux-Arts inspired Chateaux to stunning estates in Provence, the French Country style includes decorative detailing, organic floral patterns, distressed woodwork and the use of both subdued and vibrant tones.
- Whether your tastes lean toward the formal Chateau style or the relaxed provincial style, TruStile's French Country series will take your design sensibilities back to the high style of French art and architecture.



FRENCH COUNTRY  
BEAUX ARTS  
CHATEAU  
NEW EUROPEAN

Art and style that is intrinsically French marries casual charm with understated elegance. Find it here.

PROFILE SUGGESTIONS



Low Profile Bolection (LP) moulding with Double Hip (D) panel



Roman Ogee (OG) sticking with Senior Raised (E) panel



Roman Ogee (OG) sticking with Raised (A) panel

WOOD SPECIES SUGGESTIONS

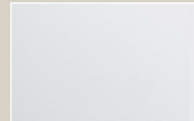

MDF/Paint Grade



Hickory



Knotty Alder



Red Oak

INSERT SUGGESTIONS



Brushed glass



Rain glass



Fossil resin

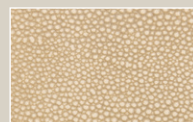

Cous Cous leather

RECOMMENDED DOOR STYLES

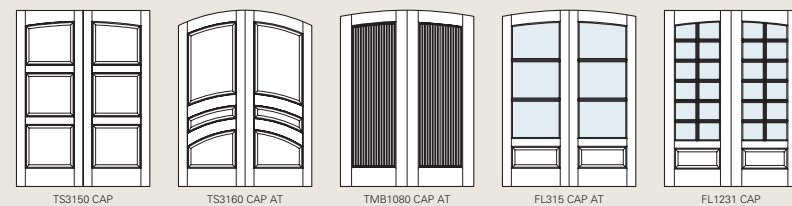
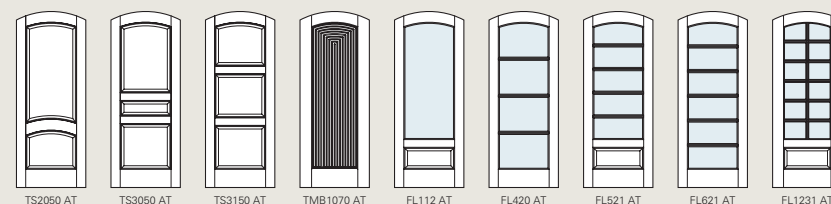
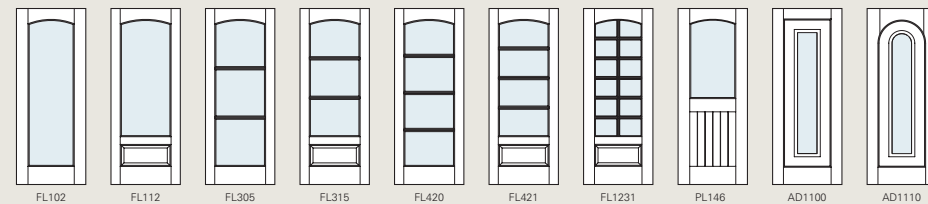
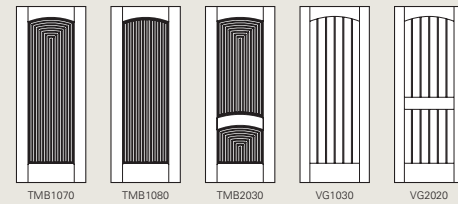
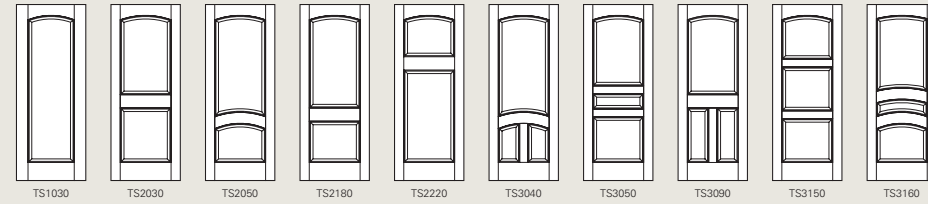

TS2050 in MDF with Low Profile Bolection (LP) moulding and Double Hip (D) panel





Radius-top TS6090 in Knotty Alder with Square Stick (SS) sticking and Raised (A) panel



## MEDITERRANEAN

An enduring trend in American architecture and interior design that expresses a Tuscan sensibility.

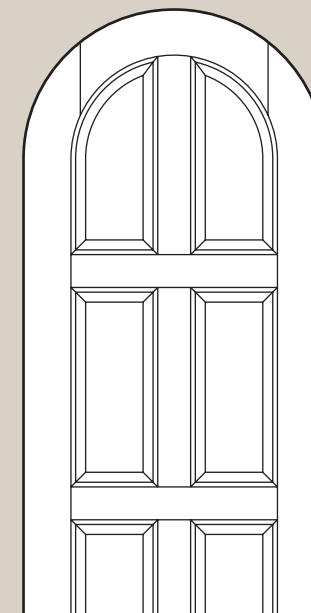

- Inspired by the Italian Renaissance, Mediterranean designs appeared in American architecture between the late 1800s and early 1900s. This movement drew heavily on Italian palaces and seaside or country villas.
- Mediterranean details include arched windows and doorways, recessed entryways, red tiled roofs and stuccoed walls.
- TruStile's Mediterranean collection brings the richness and charm of Italian living to your home.



MEDITERRANEAN  
ITALIANATE  
TUSCAN

Find the warm aesthetic of Mediterranean style through this simple yet elegant offering right here.

PROFILE SUGGESTIONS



Square Stick (SS) sticking with V-groove panel



Square Stick (SS) sticking with Raised (A) panel



Roman Ogee (OG) sticking with Senior Raised (E) panel

WOOD SPECIES SUGGESTIONS

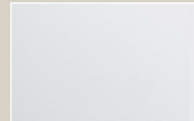

MDF/Paint Grade



Knotty Alder



Select Alder



Douglas Fir Wirebrush

INSERT SUGGESTIONS



Arctic glass



Seedy Wash glass



Patina Canterbury metal

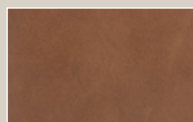

Pampas leather

RECOMMENDED DOOR STYLES

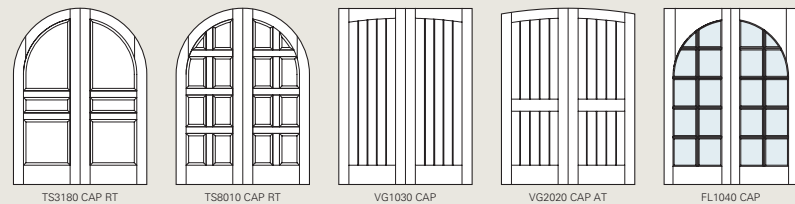
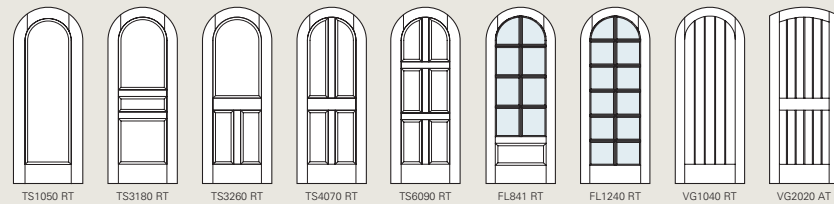
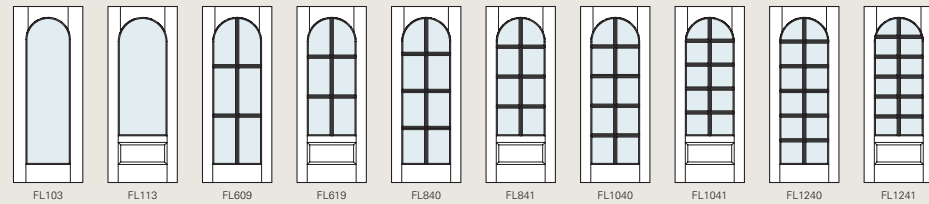
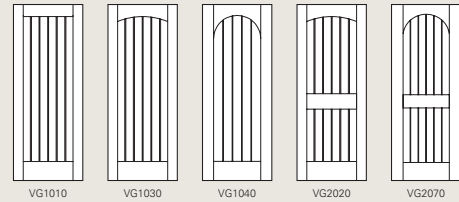

VG1000 plank door in Hickory with wide V-groove and Cappuccino stain



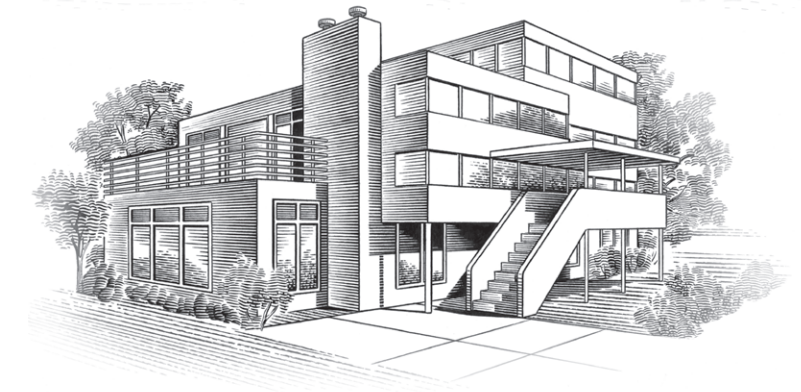

# MODERN

Clean strong lines. Bold accents.  
Custom design options.



Modified TM6100 in MDF with One Step (OS) sash and Paper Cut resin inserts

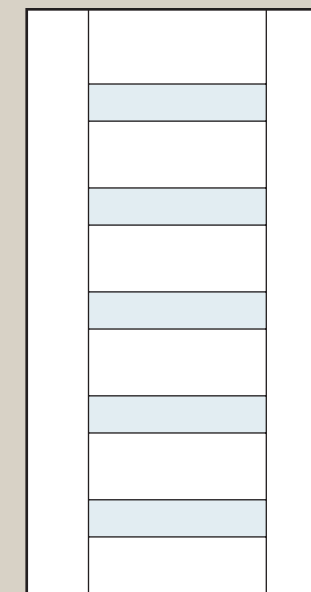

- Early Modern architecture took root in the U.S. in the 1920s and reached its peak in the mid 20th century.
- Characterized by simplification of form, an absence of ornate detail and a belief that "less is more", Modern style has streamlined horizontal lines and uses industrial materials such as concrete, steel and glass.
- TruStile's Modern Door Collection is centered around crisp, stacked rails, clean strong lines, oversized stiles, custom design options and bold accents.



MODERN  
MID-CENTURY  
USONIAN  
GOOGIE

Make a clever design statement before  
ever entering the room. Find it here.

PROFILE SUGGESTIONS



1/8" Radius reveal



1/4" Kerf Cut reveal

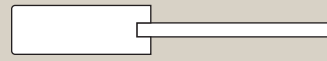

Square Stick (SS) sticking  
with Flat (C) panel

WOOD SPECIES SUGGESTIONS



MDF/Paint Grade

LVL



Walnut

Cherry

INSERT SUGGESTIONS

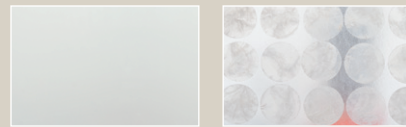

White Lami glass

Capiz resin



Patina Money metal

Wagon Lit Milk  
& Cookies leather

RECOMMENDED DOOR STYLES



TM13340 in Walnut with  
1/4" kerf cut reveal and  
White Lami glass.







VG2010 in Wire-Brushed White Oak with V-groove panels



SPANISH COLONIAL

# SPANISH COLONIAL

A warm style that exudes a sophisticated design with ornate touches.

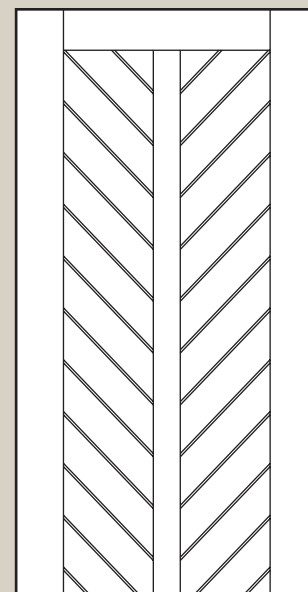

- The Spanish Colonial style of architecture was popular in the early 20th century and was embraced in both Florida and California, as well as the southwestern U.S.
- This style is characterized by smooth stucco walls, low pitched roofs, arched entryways and small porches or balconies.
- TruStile's Spanish Colonial series showcases doors with simple lines associated with today's Mission-inspired architecture as well as decorative Spanish Revival door designs.



# SPANISH COLONIAL SOUTHWESTERN MISSION

Find the warm expression of the elegant and refined Spanish Colonial style right here.

## PROFILE SUGGESTIONS



One Step (OS) sticking with Flat (C) panel



Square Stick (SS) sticking with V-groove panel



Roman Ogee (OG) with Senior Raised (E) panel

## WOOD SPECIES SUGGESTIONS



MDF/Paint Grade

Knotty Alder



Red Oak

White Oak Wirebrush

## INSERT SUGGESTIONS

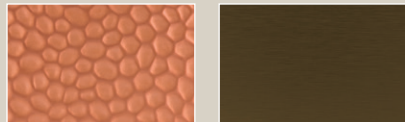

Hammered Cobblestone metal

Brushed Bronze metal



Dashing Old Sterling leather

Wave glass

## RECOMMENDED DOOR STYLES

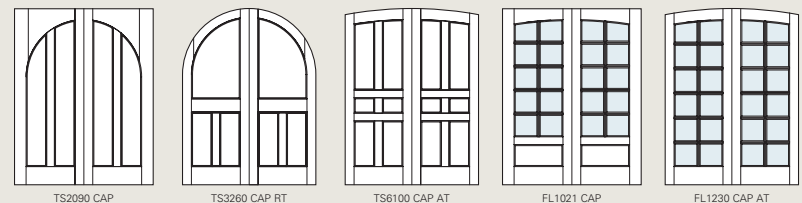
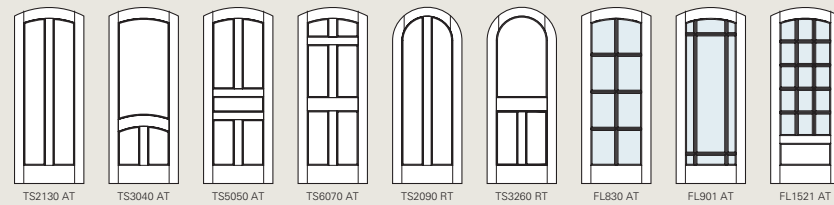
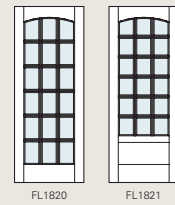
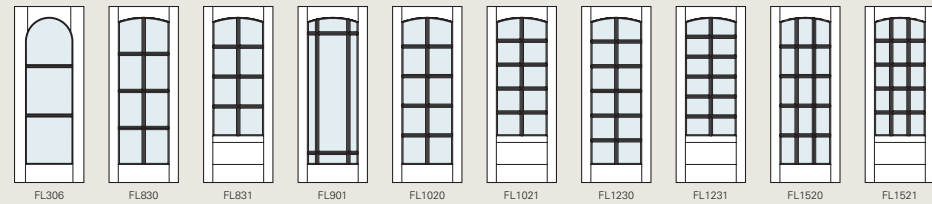
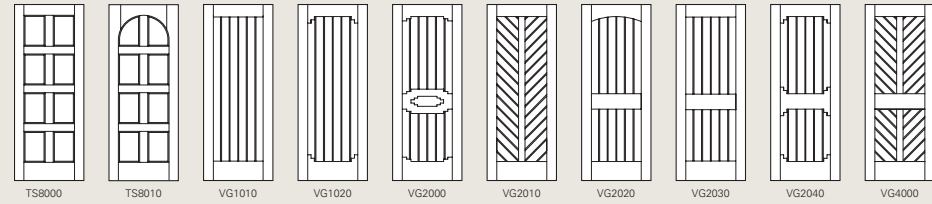
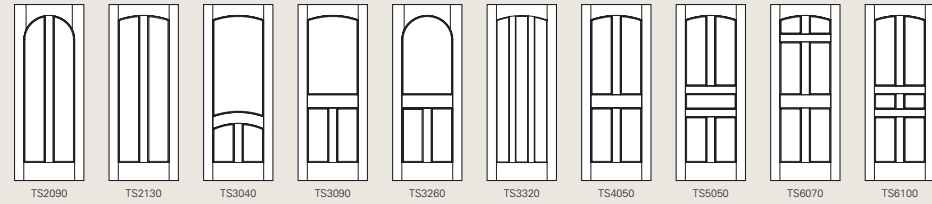

Radius-top TS2090 in Red Oak with One Step (OS) sticking and Flat (C) panel





TS4000 in MDF with custom sticking and Raised (A) panel



## TRADITIONAL

Traditional design often reflects the common sense principles of practicality and functionality.

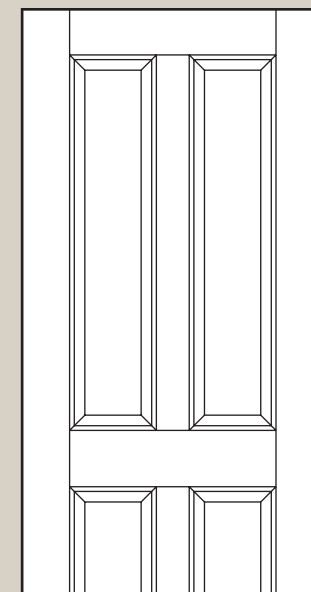

- Broadly defined, Traditional or vernacular architecture is viewed as a conservative way of building homes to retain the style and beauty of a particular community based on the localized design and historic context.
- On the East Coast, this style is most often associated with Cape Cod, Shingle or Americana styles, while in the Western U.S. the American Ranch style is predominant.
- TruStile's Traditional series reflects the classic and historic design ideas of an earlier time and place.



**TRADITIONAL  
CAPE COD  
FOUR SQUARE  
RANCH**

Bring the charm of Americana or the historic character of the New England Cape to your home with any of these doors.

**PROFILE SUGGESTIONS**



Cove & Bead (CB) sticking with Raised (A) panel



Quarter Bead (QB) sticking with Flat (C) panel



Quarter Round (QR) sticking with Raised (A) panel

**WOOD SPECIES SUGGESTIONS**



MDF/Paint Grade

Clear Pine



Mahogany

Poplar

**INSERT SUGGESTIONS**



Bevel glass

Rain glass



Reeded glass

Whirl glass

**RECOMMENDED DOOR STYLES**

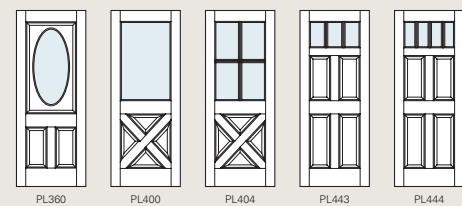
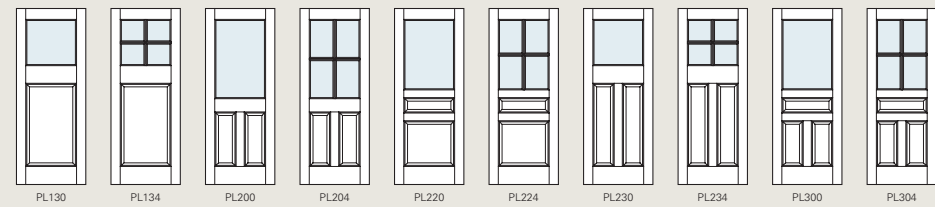
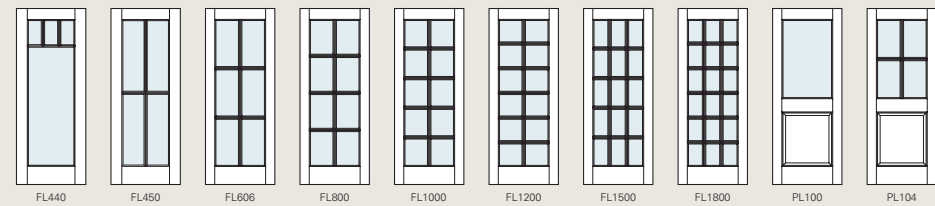
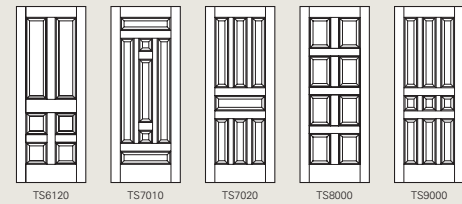
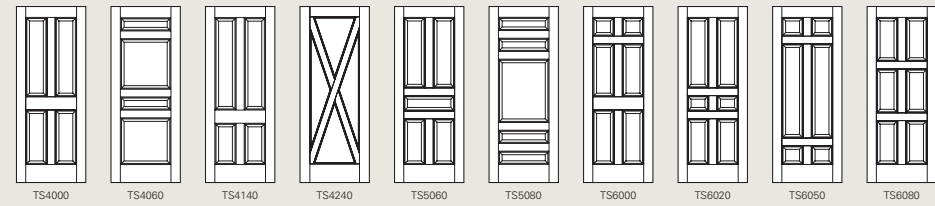

TRADITIONAL



FL800 in MDF with Roman Ogee (OG) sash and Clear glass





AD1110 in Walnut with Square Stick (SS) sticking, Flat (O) panel and Reeded glass insert



## TUDOR

Tudor architecture reflects a return to a more conservative and formal aesthetic.

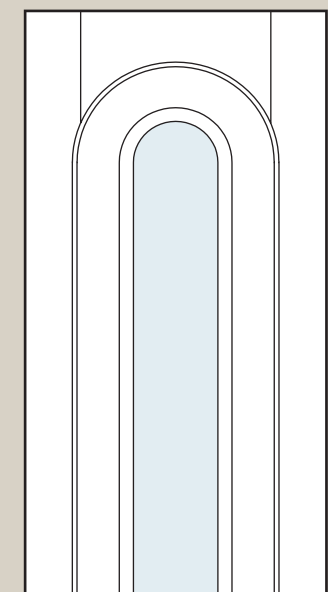

- The Tudor period was a distinct part of the Revivalist period in architectural history.
- The Tudor home features steeply pitched gabled roofs, high chimneys, tall mullioned windows and half-timbering.
- Inspired by English manor homes, the TruStile Tudor series features an assortment of elegant designs and gentle arches.



**TUDOR**  
**ENGLISH TUDOR**  
**TUDOR REVIVAL**

TruStile's Tudor series will bring a touch of English charm to your home. Find it here.

**PROFILE SUGGESTIONS**



Cove & Bead (CB) sticking with Double Hip (D) panel



Low Profile Bolection (LP) moulding with Raised (A) panel



Roman Ogee (OG) sticking with Raised (A) panel

**WOOD SPECIES SUGGESTIONS**



MDF/Paint Grade

Mahogany



Walnut

Select Alder

**INSERT SUGGESTIONS**



Glue Chip glass

Obscure glass



Dashing Old Sterling leather

Pampas leather

**RECOMMENDED DOOR STYLES**

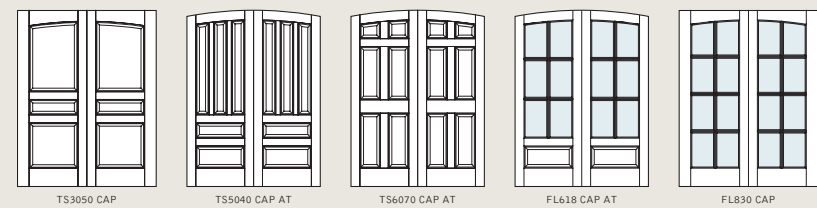
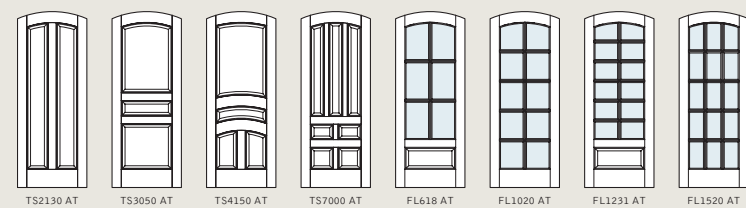
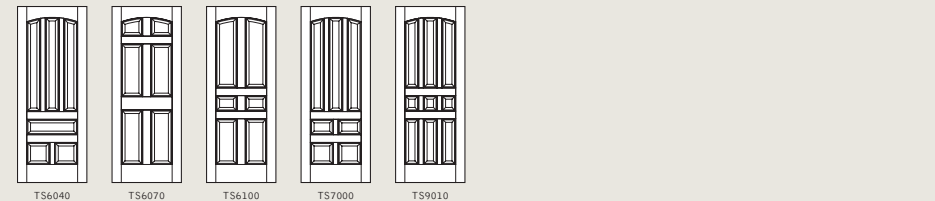

Arch-top TS3050 in MDF with Roman Ogee (OG) sticking and Raised (A) panel





Radius-top modified TS3180 in White Oak with Bolection (BM) moulding and Raised (A) panel



## VICTORIAN

Where unconventional ideas took root and elaborate styles came to light.

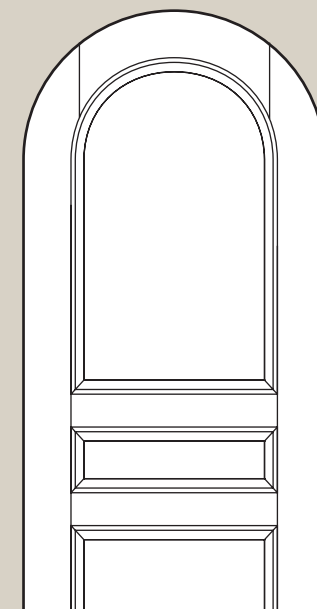

- The Victorian era of architecture reigned from the 1830s until the beginning of the 20th century and was known as a period of romanticism.
- Ornamentation such as gingerbread detailing or Victorian lace is frequently used. Roof lines tend to be accented with hipped gables, towers and dormers.
- The ornate nature of the TruStile Victorian door line effectively reproduces this historic time period within your home.



VICTORIAN  
QUEEN ANNE  
GOTHIC

Romantic expression and imagination are emphasized in the Victorian style. Find it here.

PROFILE SUGGESTIONS



Big Bolection (BB) moulding with Scoop (B) panel

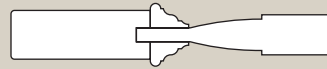

Bolection (BM) moulding with Senior Raised (E) panel

WOOD SPECIES SUGGESTIONS



MDF/Paint Grade

Mahogany



Clear Pine

White Oak

INSERT SUGGESTIONS



Bevel glass

Reeded glass



Seedy Wash glass

Croc Black Leather

RECOMMENDED DOOR STYLES

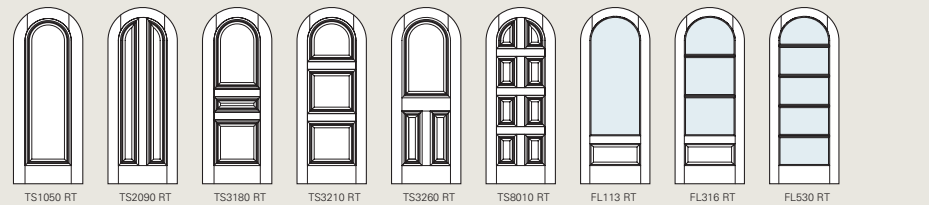
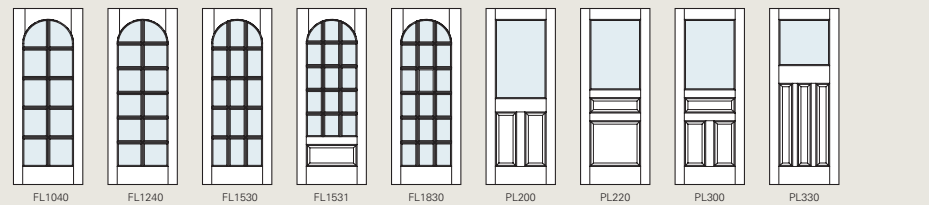
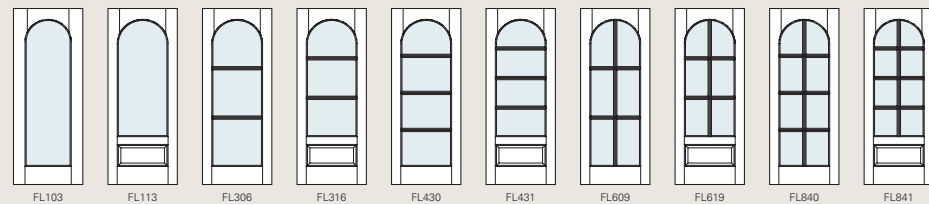
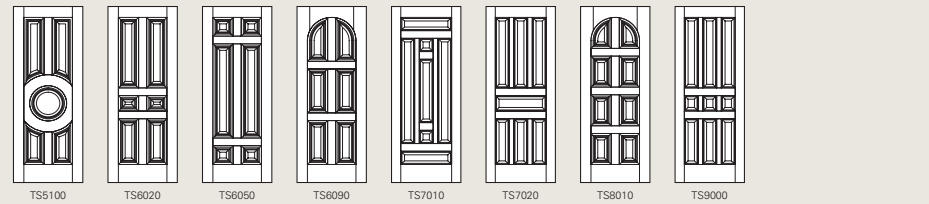
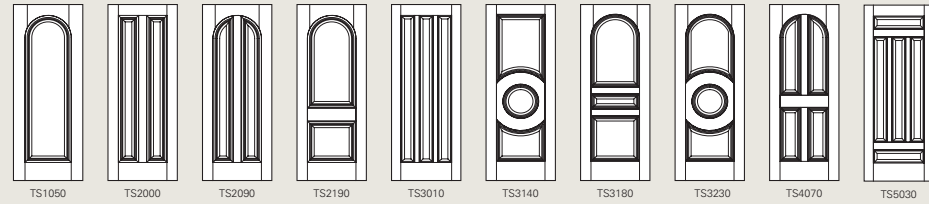

TS4070 Radius top in MDF with Roman Ogee (OG) sticking and Raised (A) panel





## Design Options

Like furnishings and décor, doors should complement your home's unique architecture and individual style. TruStile Doors provide you with ultimate flexibility, offering unique design options including accents of metal, glass, resin and leather; common arch pairs and built-in mirrors — just to name a few.

TS3000 pocket door in MDF  
with Narrow Reed glass



TS3000 in MDF with Custom sticking and Senior Raised (E) panel



## Ideal for Painted Applications

## TruStile MDF Doors

TruStile MDF Doors provide quality that is unrivaled. Our super-refined MDF material and meticulous construction methods result in a painted door product that is a cut above the rest.

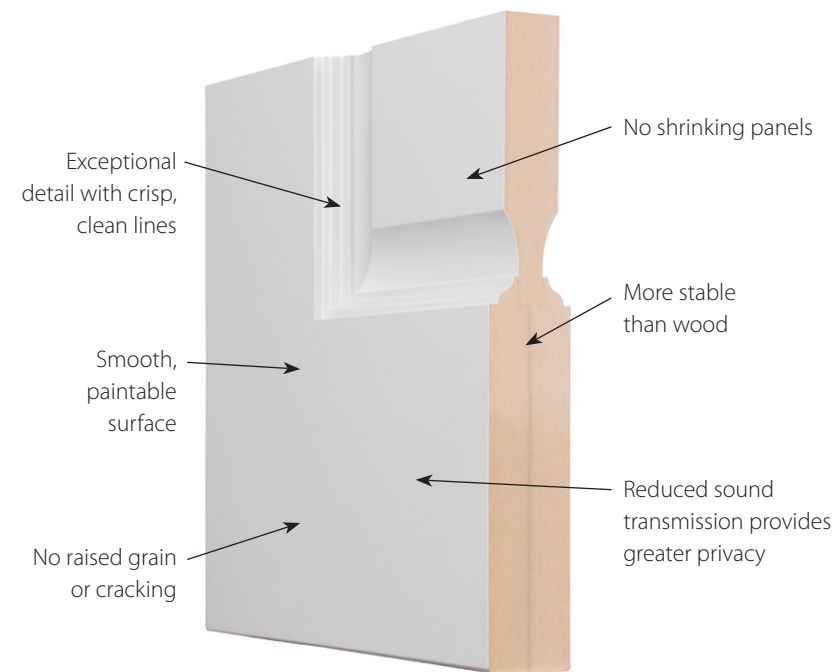

- Made to order and built to any size and style.
- Built with genuine stile and rail construction — never routed or stamped.
- Made with solid, super-refined MDF that provides a smoother painting surface than pine, poplar or lower-grade MDF alternatives.
- MDF is more stable than natural wood and less susceptible to movement and warping.
- More affordable than wood doors.
- Third party certified by Scientific Certification Systems to contain 69% recycled content, making them ideal for green building.

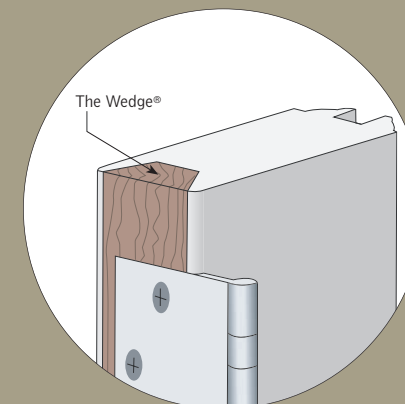

### HARDWOOD WEDGE EDGE SYSTEM

TruStile MDF doors come standard with The Wedge,<sup>®</sup> our field-proven hardwood edge system. Designed to stand up to daily use, The Wedge provides superior rigidity, stability and screw-holding power.



TM13340 in Walnut with  
Edelman® Royal Hide  
Pewter Leather

For the Most  
Discerning Eye

## TruStile Reserve™ Wood Doors

Designed to the highest level of quality, TruStile Reserve™ Wood Doors are the ultimate expression of luxury for today's interiors and are constructed using the latest technological advances combined with meticulous hand craftsmanship.



**TRUSTILE**  
RESERVE™

- The TruStile Reserve series incorporates only the finest materials and methods. We have developed a proprietary specification based on the AWI (Architectural Woodwork Institute) standard for AA Premium Grade doors.
- Engineered panel made with a composite core for strength and stability while maintaining the look of a solid wood panel construction.
- Precision-cut cope and stick joinery for a meticulous, uncompromising look.
- The strength and durability of LSL is employed for the ultimate in stiffness to resist bowing, twisting or warping.

### EXCEPTIONAL HAND-MATCHED VENEERS

TruStile created a proprietary color matching and grading system to ensure only the best veneers and lumber are used to handcraft your door. Based on the AWI AA Premium Grade standard, but taken a step further, TruStile Reserve Doors are unmatched in beauty.



For the  
Harmonious  
Home

## TruStile Wood Doors

Made in the authentic stile and rail manner, TruStile Wood Doors use a premium mix of materials that exceed industry standards for a truly natural look.

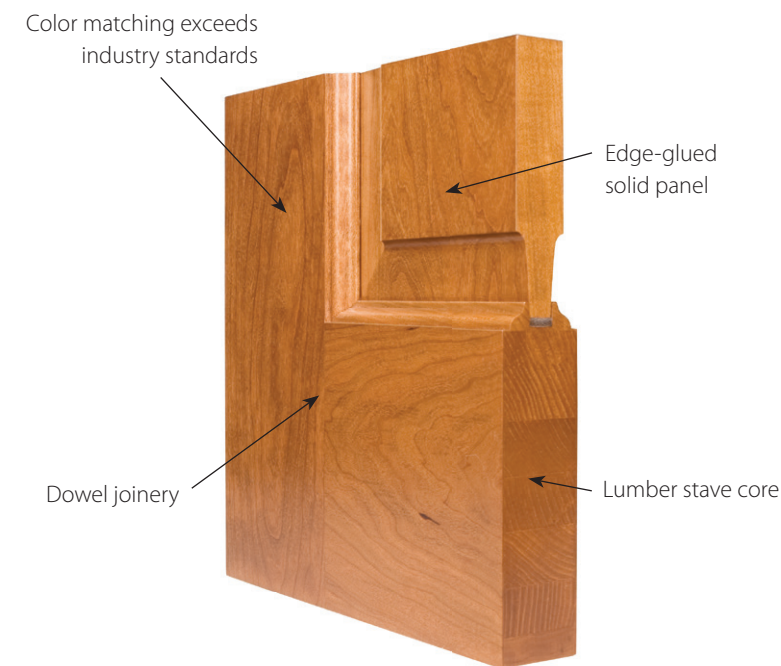

- Parts are tested and sorted into a premium mix of components that exceed industry standards. All components are blended for color and grain pattern matching.
- Edge-glued solid wood panels for a premium look and feel.
- Traditional dowel construction enhances strength and durability.
- An engineered stave lumber core is cut to size with alternating grain patterns, which balances the core and reduces wood's natural tendency to move.

### Floating Panel System

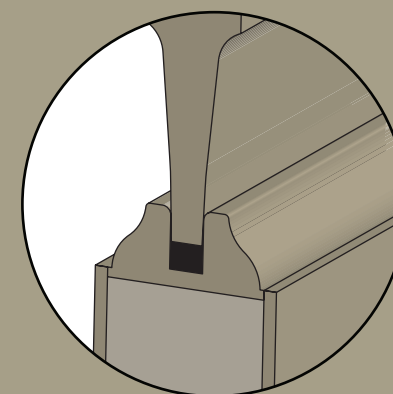

### PANEL RETENTION

TruStile doors are engineered with a unique floating panel system that allow expansion and contraction while securing the panel to prevent shifting, settling and rattling. Flexible cushions are inserted into the stile and rail grooves followed by the panels that rest against them. The cushions allow the wood to expand and contract while holding the panel in position.

TS3010 in Cherry with  
Roman Ogee (OG) sticking  
and Raised (A) panel





## Wood Species

We offer the broadest selection of wood species on the market. Choose from 20 standard selections of the finest, hand-selected veneers and lumber. Or custom order virtually any species.



Bamboo

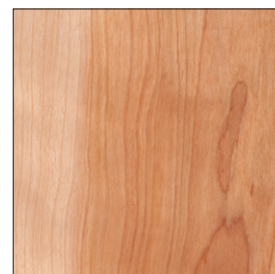

Birch

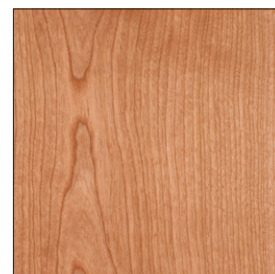

Cherry



Clear Pine



Wire-Brushed Clear Pine



Douglas Fir  
(Vertical Grain)



Wire-Brushed Douglas Fir  
(Vertical Grain)

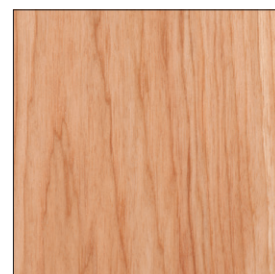

Hickory

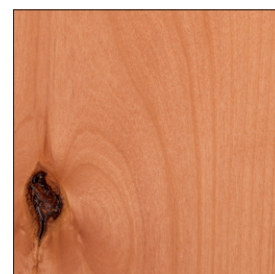

Knotty Alder



LVL



Mahogany



Poplar

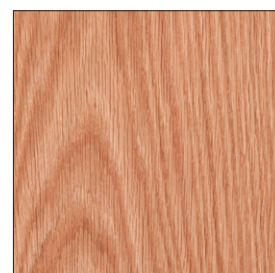

Red Oak

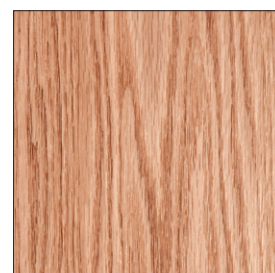

Wire-Brushed Red Oak



Select Alder

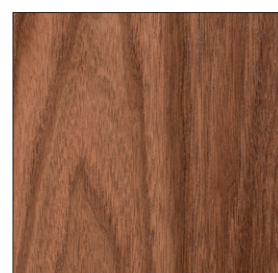

Walnut

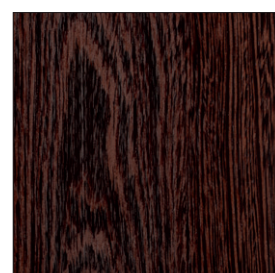

Wenge



White Maple



White Oak  
(Quarter Sawn)

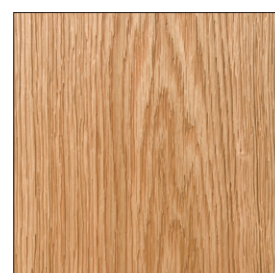

Wire-Brushed White Oak  
(Plain Sawn)

## Perfection is in the Details

## Factory Pre-Finishing

TruStile offers a premium finishing capability that accentuates the natural beauty of our doors. Our exclusive process combines hand-wiped stains with a catalytic conversion varnish that results in an exceptionally beautiful finish luster.

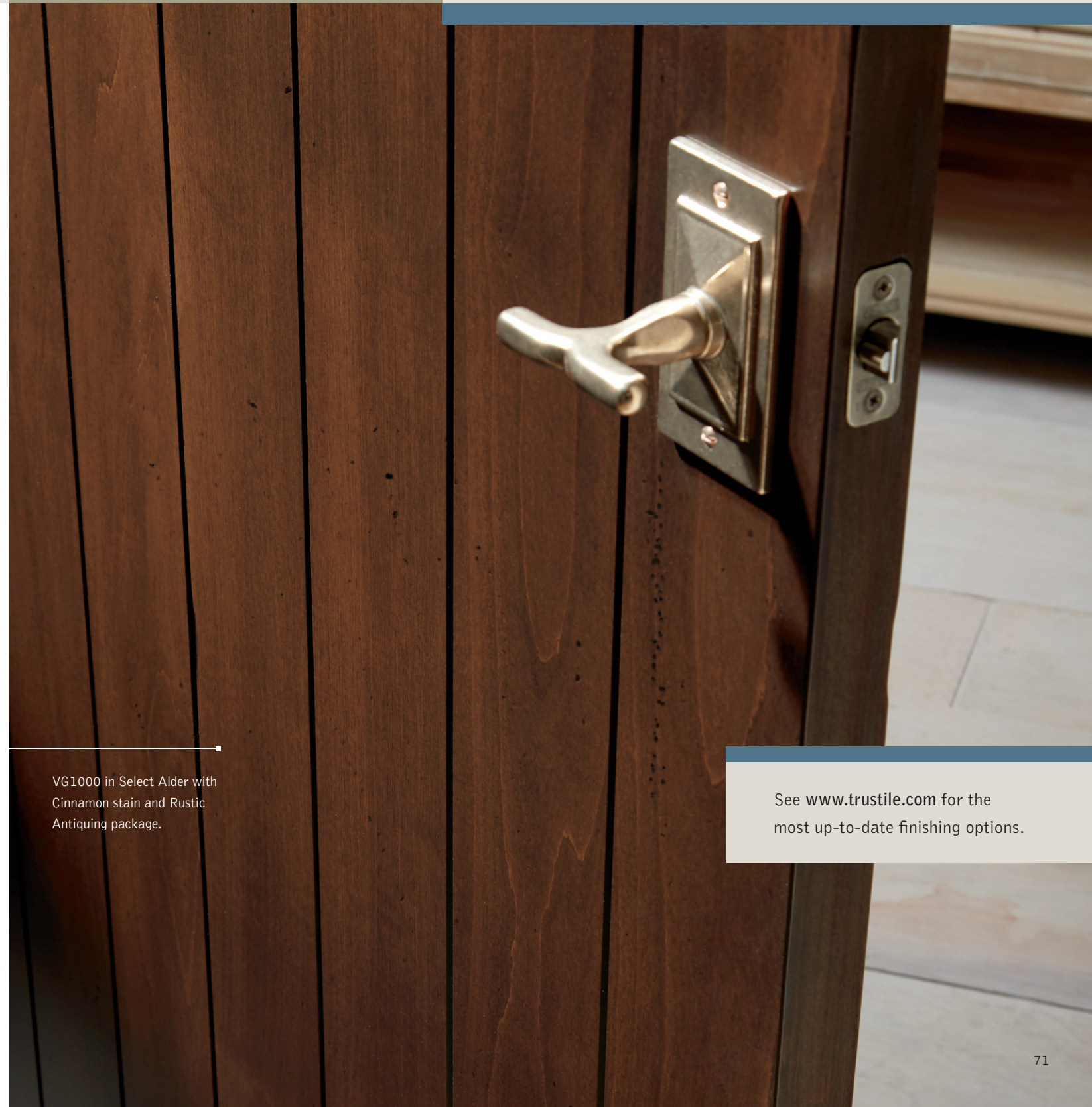

VG1000 in Select Alder with Cinnamon stain and Rustic Antiquing package.

See [www.trustile.com](http://www.trustile.com) for the most up-to-date finishing options.



## Exterior Doors

TruStile offers most panel and glass styles in exterior-grade MDF and natural wood. Built with our stile and rail process, exterior doors are backed by our limited lifetime warranty when properly finished and installed with proper overhang protection.

### EXTERIOR MDF DOORS

TruStile's exterior MDF doors receive specially engineered stiles, rails, and panels, along with an exterior-grade MDF material, to ensure they perform in changing environmental conditions. In addition, all exterior MDF doors receive our exclusive TruBolt system with threaded bolts running through the top and bottom rails to ensure structural integrity.

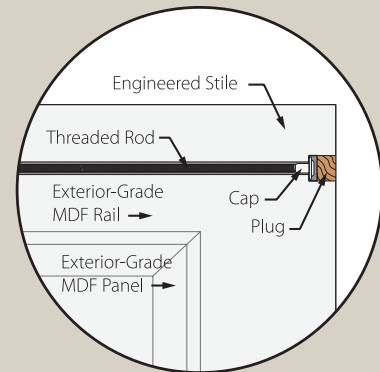

All exterior MDF doors come with our exclusive TruBolt system for added strength



TS5000 in exterior-grade MDF with White Lami glass



TM5100 in Walnut with White Lami glass

### TRUSTILE RESERVE EXTERIOR WOOD DOORS

TruStile Reserve exterior wood doors come with engineered LVL stiles & rails that are triple doweled for optimal strength and security. Our Sentry Protection System provides an additional barrier to the elements with a polyurethane sealed channel around the full perimeter of all panels and glass.

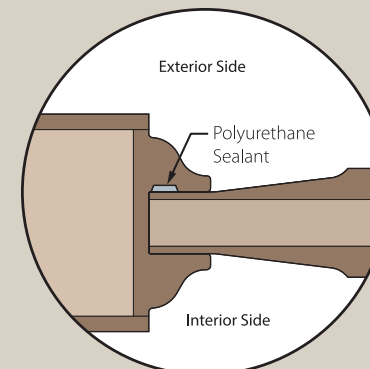

The Sentry Protective System provides a weatherproof seal around all panels and glass



## Factory Pre-Hanging

Like our doors, TruStile's pre-hung units are built using premium construction techniques. Available as either pre-hung units or knock-down jambs, TruStile can supply any width and any species for any size door.

### Available Hinge Finishes

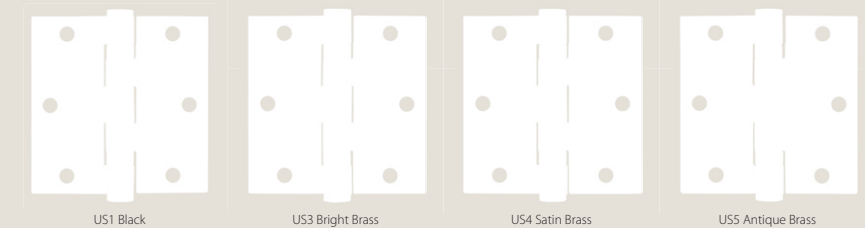





## Edelman® Leather

Substitute any panel with the finest Edelman leather. Select either a laminated or upholstered finish to refine your design.

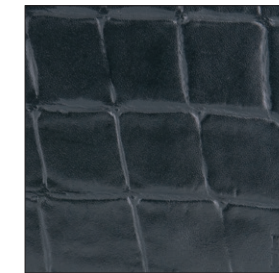

Croc Black

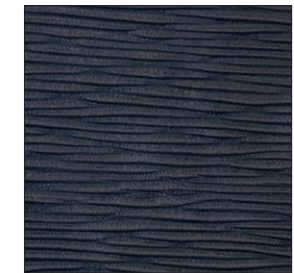

Sulky Grey Mare



Shagreen Café Latte

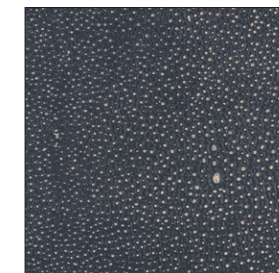

Shagreen Caviar



Shagreen Couscous



Shagreen Grey Oyster

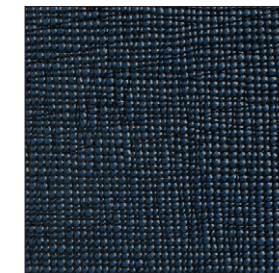

Wagon Lit Newest Navy

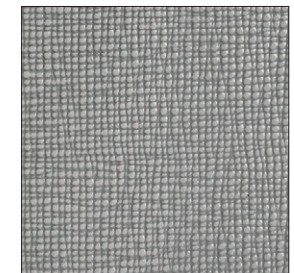

Wagon Lit Sonic

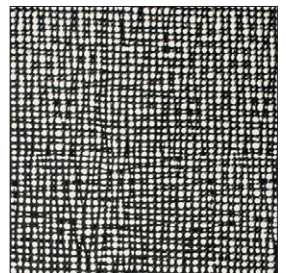

Wagon Lit Milk & Cookies



Dashing Old Sterling



Old Cherry



Pampas

In addition to our 12 standard color ways, visit [www.edelmanleather.com](http://www.edelmanleather.com) for hundreds of additional choices.

TM6100 barn doors in white oak with Shagreen Grey Oyster leather and One-Step (OS) sticking.



# Chemetal® Inserts

High-quality wood and imaginative finishes combine for an entirely new perspective on what a modern interior can be. Choose the insert that inspires you.



Brushed Aluminum



Brushed Brass



Brushed Bronze

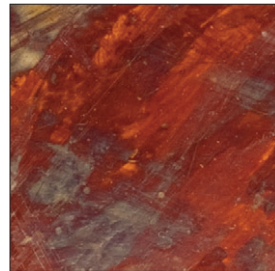

Patina Aurora

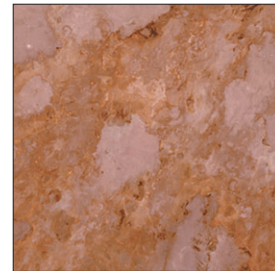

Patina Canterbury

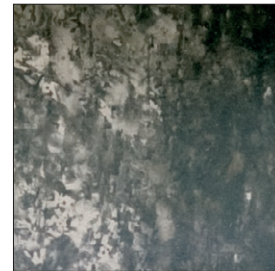

Patina Monet

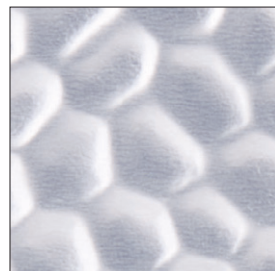

Hammered Argenta

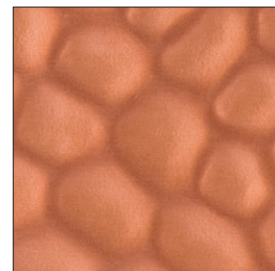

Hammered Cobblestone

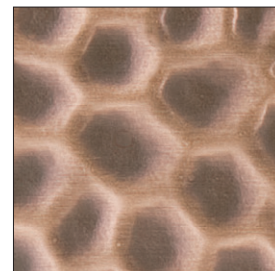

Hammered Reptilian

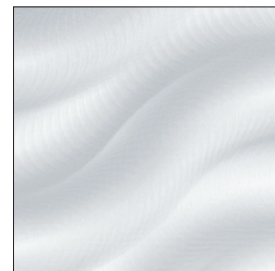

Serpentine

TM3000 in MDF with Patina Monet panels



In addition to our standard finishes, visit [www.chemetal.com](http://www.chemetal.com) for hundreds of additional choices.



# Innovative Glass and Resin

Replace most any panel with the latest trends in architectural glass from Bendheim® or designer resin from 3Form®

Visit [bendheim.com](http://bendheim.com) or [3-form.com](http://3-form.com) for more custom choices.



Clear



Bevel

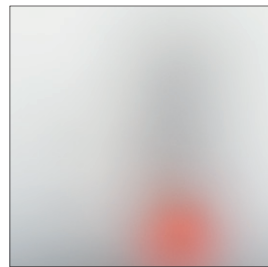

Frosted

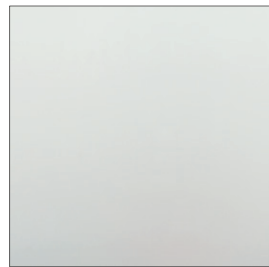

White Lami

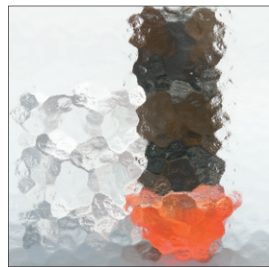

Arctic

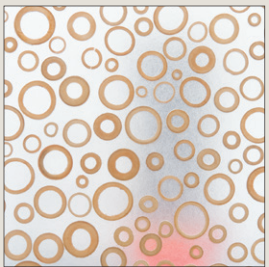

Bamboo Rings

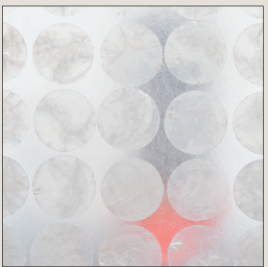

Capiz

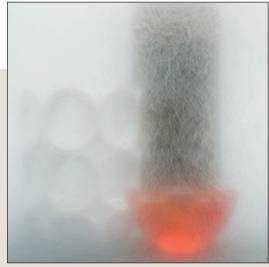

Brushed

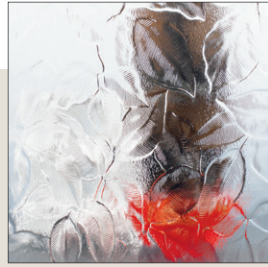

Clear Leaf

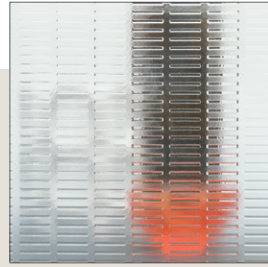

Dash

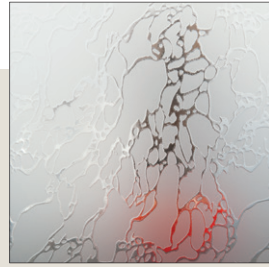

Delta Frost



Flow

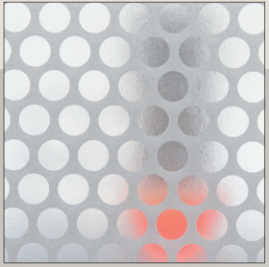

Cirque

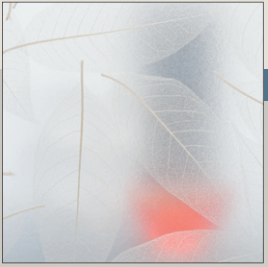

Fossil



Glue Chip



Groove

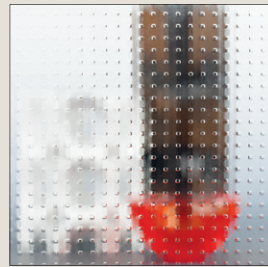

Master Carre



Obscure



Pinstripe



Ginkgo Thatch



Thatch

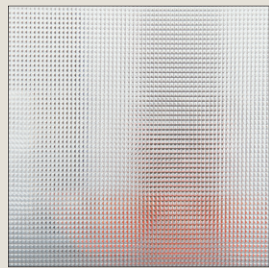

Quadra



Rain

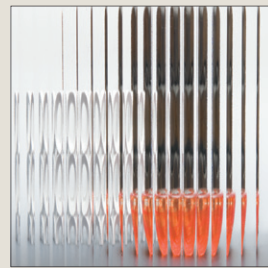

Reeded

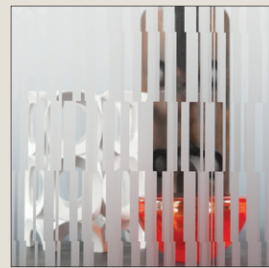

Satin Barcode



Seedy Wash

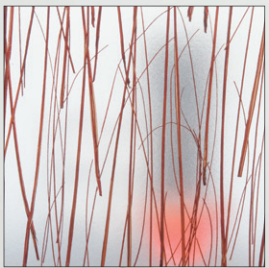

Ting Ting

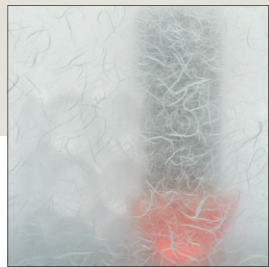

Shoji

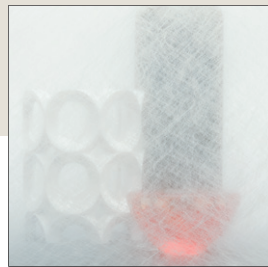

Spun

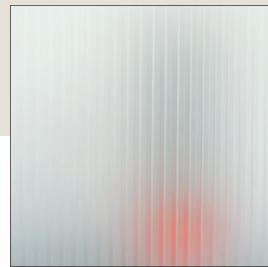

Tuxedo



Wave

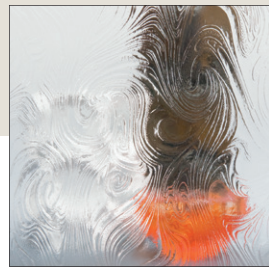

Whirl



Clear mirror



Bronze Fibers Mirror

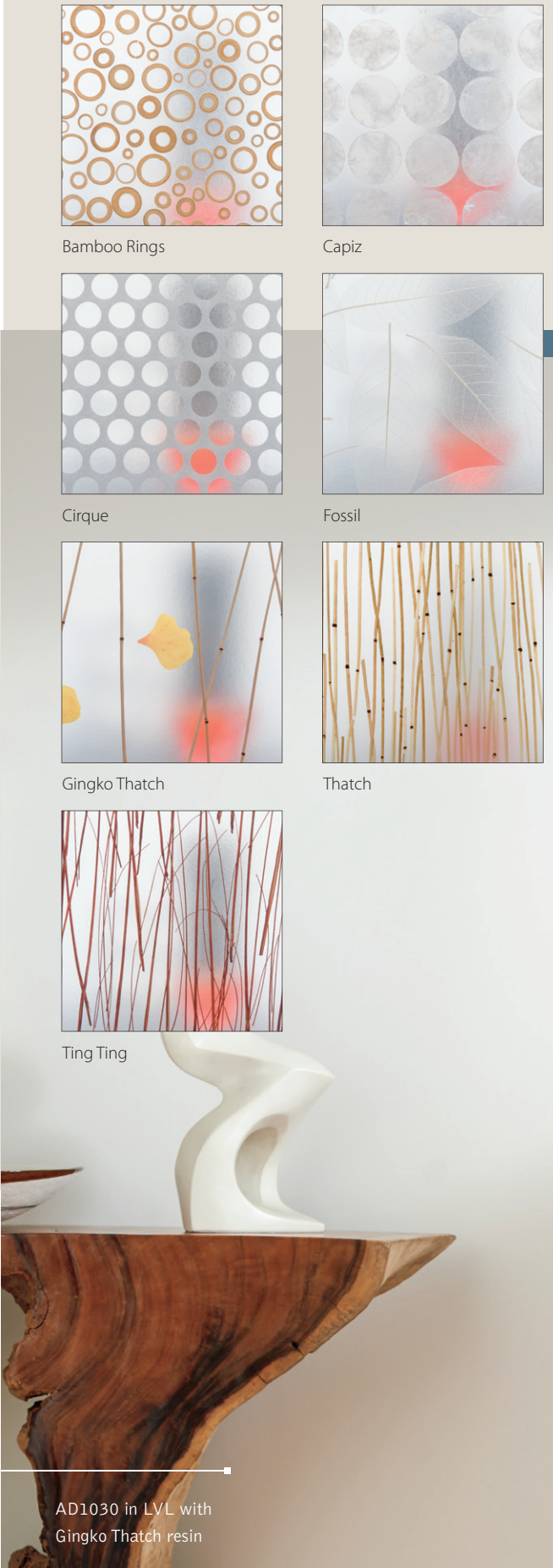

AD1030 in LVL with Ginkgo Thatch resin





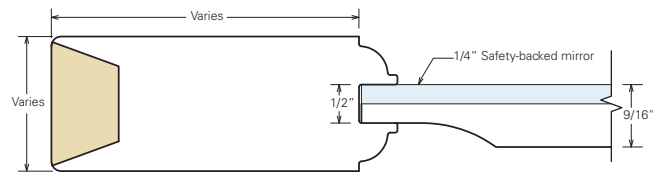

Sample cross section (one-sided mirror door)

## Built-In Mirrors

TruStile mirror doors add a new dimension to any space. Our mirror doors are a perfect space-saving solution for bathrooms, closets, dressing rooms and other applications where a full-length mirror is required on one side.

Achieve total design form and function by substituting any wood panel for a mirror. Standard options include clear mirror and bronze fibers mirror.



Clear mirror



Bronze Fibers mirror

**REFLECT THE HIGHEST STANDARDS**

Specify a full-length, built-in mirror on the back of any of our panel doors.



Backside of TM9000 in MDF features built-in mirror. TM5000 with White Lami glass on right.

## Custom Etched Glass

Looking for something special for a pantry, wine cellar or office door? TruStile can custom etch any pattern, word or logo onto your glass doors.





# Customize Your Doors with Unique Options

## Design Options

TruStile's made-to-order flexibility makes it easy to customize the look of our 400+ standard doors with a collection of unique door options.



VG2020 AT in douglas fir

Arch-top doors



TS4070 RT in MDF

Radius-top doors



TM9320 in MDF with Brushed glass

Sliding barn doors



FL1500 in mahogany

Pocket doors



TS3160 in MDF

Bi-fold doors



VG2020 in MDF

Bypass doors



TM9140 in LVL with custom metal

Pivot doors



TS2060 in MDF

Clipped corner doors

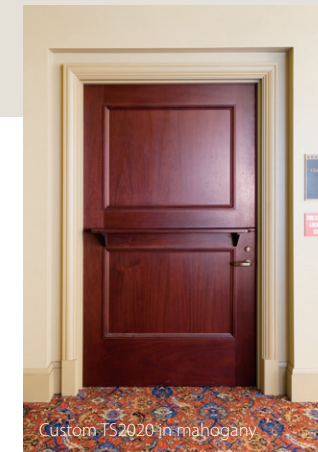

Custom TS2020 in mahogany

Dutch doors



Custom TS5060 in MDF

Specialty doors



TS3040 standard pair



TS3040 common arch pair

### Common Arch Pairs

Rather than placing two matching doors side by side, common arch pairs carry details across both doors, such as curved panels and rails. The end result? The doors actually look like they were made for the opening. Common arch pairs are also available with arch and radius tops.





VG4030 barn door in MDF



## Sliding Barn Doors

We've re-imagined our entire product offering of 400+ styles to make them compatible for barn door openings. As the width increases, the design changes to create the appropriate look.

### Rustic (VG4030 shown)

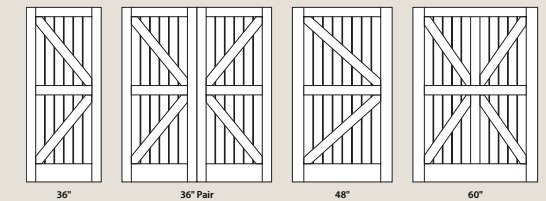

### Craftsman (PL244 shown)

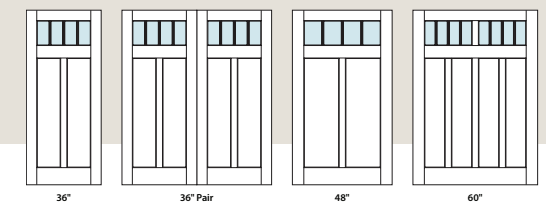

### Traditional (TS3040 shown)

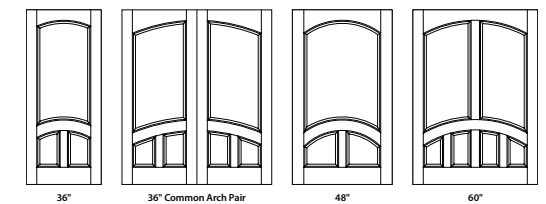

### Modern (TM9110 shown)

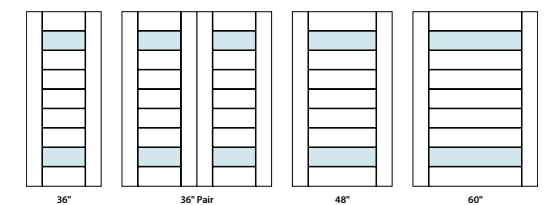





## Tru&Modern Infinite Rail Doors

Modern architecture demands exacting specifications. The Tru&Modern Infinite Rail brings a luxurious level of sophistication with kerf cuts or metal inlays that traverse the complete width of the door.

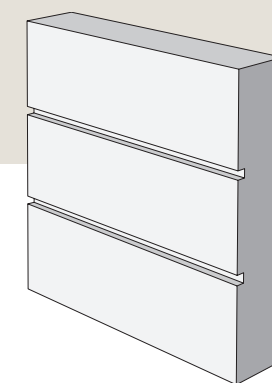

1/4" Kerf Cut Reveal

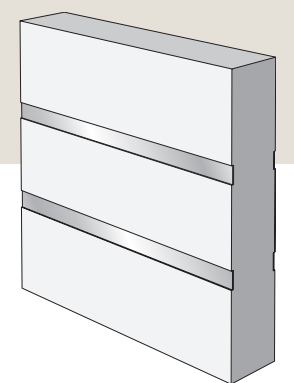

1/2" Bright or Brushed  
Stainless Inlay

TMIR6080 in Mahogany with Espresso stain and 1/2" Bright Stainless Steel Inlay



## Tiered Mouldings

The Linea, Miracle and Avant Mouldings bring interest and dimension to square panel doors. These timeless styles enhance traditional designs with a dynamic, contemporary look.

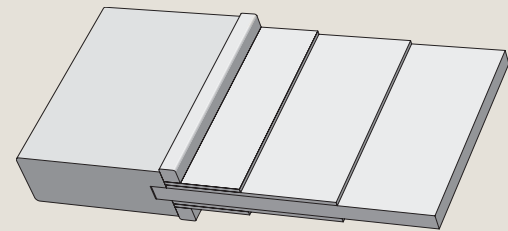

Linea Moulding

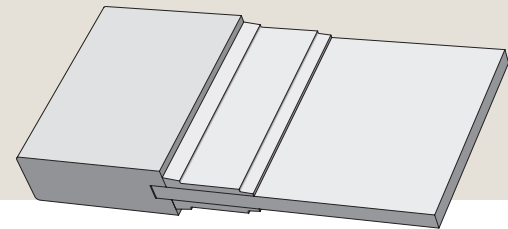

Miracle Moulding

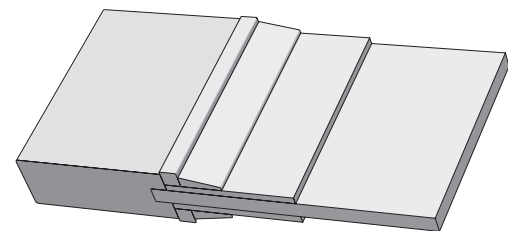

Avant Moulding



TS2060 in MDF with Linea (LN)  
Moulding and Flat (C) panel





VG1000 Plank Door in Select Alder with Cinnamon stain with Rustic Antiquing package

## Plank Doors

Achieve the genuine look of rustic plank doors or create your own contemporary version of this ageless design. Multiple profiles, plank widths and finishing options make it all possible.

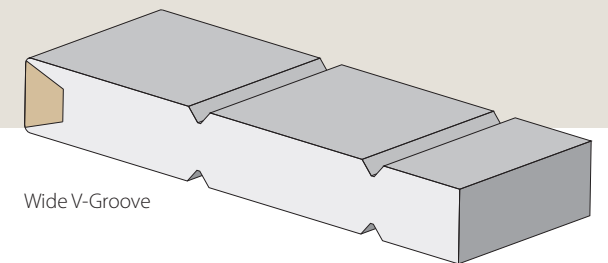
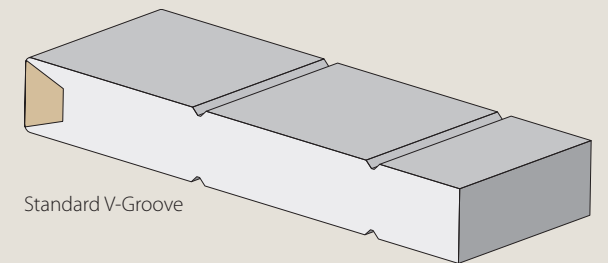





Wall Finish  
by  
GORMAN CUSTOM  
FINISHES

TS5080 in White Oak with Quirk moulding, with metal inlay, and White Lami glass



## Commercial Applications

From hospitality and high-end multifamily projects to health care and educational institutions, TruStile provides the right finishing touches for distinctive projects across the United States.

TruStile doors can be built to meet any commercial specification — including 20- through 90-minute fire ratings, ADA requirements and sound ratings.



# Transform Openings & Elevate Your Project

TruStile designs premium doors for a wide array of market segments and distinctive properties across the United States.



## Design Consistency Regardless of Function

Providing ultimate design flexibility, TruStile offers a spectrum of products for every project application. Whether passage, glass, fire or sound doors, TruStile allows you to maintain design consistency across all of your openings.

### RECENT PROJECT PORTFOLIO

#### Hospitality

##### Boutique Hotels & Spas

- Ace Hotel
- Albany Bahamas
- Algonquin Hotel
- The Jefferson Hotel
- Lake Yellowstone Hotel & Cabins
- Little Dix Bay
- Mills Park Hotel
- Mirbeau Inn & Spa
- Win-River Resort & Casino

##### Resorts & Destination Hotels

- Fairmont Hotel—San Francisco
- Four Seasons—Boston
- JW Marriott—Washington DC
- Hilton—Nashville
- Hilton—Waikola
- Marriott—West Palm Beach
- Millennium—Scottsdale
- Omni Hotel—Amelia Island
- Renaissance—Aruba
- Renaissance—Austin
- Ritz Carlton—St Thomas
- Sheraton—Steamboat Springs
- Westin—Atlanta
- Westin—Hilton Head
- Wyndham—Puerto Rico

#### Education

- Auburn University – Duncan Hall
- Butler University – Delta Gamma
- Columbia University – Teachers College
- Cristo Rey High School
- Dartmouth College – Kappa Delta
- Middlesex School
- Notre Dame Community Housing
- Pepperdine Student Apartments
- Phillips Exeter Academy
- University of New Haven Dormitory
- Vassar College

#### Healthcare

- Cohasset Senior Center
- Cosmetic Surgery Center of Maryland
- Brightmore of South Charlotte
- Friendship House at Royal Oaks
- Mount St Joseph
- OK Kids Korral
- Tockwotton on the Waterfront

#### Government/Public

- Chester County Courthouse
- Denver Union Station
- Dumbarton Oaks
- Fort Poke Office Building
- Santa Cruz Women’s Shelter
- Sumter County Courthouse
- Presidio Officer’s Club

#### Office/Retail

- Athleta/Gap/Banana Republic
- Bass Pro Shops
- Beverly Bank
- Chicago Motor Club
- First Southern Bank
- Goldring Office Building
- Grubbs Infiniti Dealer
- Waters Professional Building
- White House Black Market

#### Multi-Family

- 333 North Michigan Avenue
- 530 Park Condo
- 1301 North Astor Street – Phillip Maher Building
- Adam Gordon’s 560 West Chelsea
- The Aurora Apartments
- The Austonian
- Coronado Bay Club
- Huys—404 Park Avenue South
- Hotel Sorella Residences
- Loews North Park Drive
- Mansions at Aqualina
- Old Mill Toronto
- Printhouse Lofts, Brooklyn
- Rittenhouse Plaza
- The Shire
- Two Twenty Four Mulberry Street
- Uptown Condos

#### Entertainment

- Canoe Brooke Country Club
- Charles River Country Club
- Cuban Museum
- Eugene O’Neill Theater Center
- Gaithersburg Art Barn
- The Hermitage Club
- Jazz and Heritage Center
- Kansas State Casino
- Noah’s of Katy at Mason Creek
- Universal Studios/Harry Potter
- Woodforest Golf Club

#### Religious

- Benedictine Sisters Retreat Center
- Good Shepard Catholic Church
- Mission Del Ray
- Parkside Church
- St George Christian Church



TS2020 in MDF with custom sticking



TM9000 in White Oak



TS2080 in Mahogany



Custom LVR2020 sliding barn doors in MDF





TS5000 in MDF with White Lami glass

## Design that Complements the Planet

Our modern, domestic plants use lean manufacturing practices to make extremely efficient use of our raw materials. This minimizes waste and environmental impact.

### 69% Recycled MDF Doors for Painted Applications

TruStile MDF doors are not only the highest quality paintable doors on the market, they are also the responsible environmental choice. We recycle MDF waste, donating it to agricultural partners who use it to create energy, reducing both landfill waste by 65% and waste pick ups, putting fewer trucks on the road. The green benefits of our MDF doors include:

- Certified by SCS Global Services to be constructed of 69% recycled content.
- Eligible for up to three LEED® credits
- Manufactured with low-emitting adhesives and coated with low-emitting primer.
- Standard MDF is low emitting, meeting CARB (California Air Resources Board) requirements.
- A no-added formaldehyde MDF option is also available.



### FSC® Certified Wood Doors for Stained Applications

Most TruStile wood doors are available with FSC certification. FSC certification ensures that products come from responsibly managed forests that provide environmental, social and economic benefits.

The green benefits of our FSC certified wood doors include:

- Third-party certification that all door materials originate from responsible sources.
- 100% of door value contributes towards the LEED credit for Certified Wood Products.
- Manufactured with low-emitting adhesives.
- Green-certified doors contain the same high-quality construction and materials as our standard product.



The mark of responsible forestry



## Use TruStile on Your Next LEED® Certified Project

The LEED® (Leadership in Energy and Environmental Design) Green Building Rating System is a national standard developed and published by the U.S. Green Building Council (USGBC). Its purpose is to promote sustainable building that is environmentally responsible, profitable and healthy. TruStile doors also qualify for other green building rating systems. Contact us for details.

TruStile Doors help achieve LEED credits in the following categories for new commercial construction and major renovation projects<sup>1</sup>:

LEED credit	LEED criteria	Detailed requirement	TruStile MDF	TruStile Wood
<b>Materials &amp; Resources</b>				
4.1 (1 point)	<b>Recycled content:</b> 10% (post-consumer + ½ pre-consumer)	Use materials with recycled content such that the sum of post-consumer recycled content plus ½ of the pre-consumer content constitutes at least 10%, based on cost, of the total value of the materials in the project.	Qualify—SCS certified to contain minimum 69% recycled content	Not eligible
4.2 (1 point)	<b>Recycled content:</b> 20% (post-consumer + ½ pre-consumer)	Use materials with recycled content such that the sum of post-consumer recycled content plus ½ of the pre-consumer content constitutes at least 20%, based on cost, of the total value of the materials in the project.	Qualify—SCS certified to contain minimum 69% recycled content	Not eligible
7 (1 point)	<b>Certified wood</b>	Use a minimum of 50%, based on cost of wood-based materials and products that are certified in accordance with the Forest Stewardship Council's (FSC) principles and criteria for wood building components.	Not eligible	Qualify—specify FSC Certified Wood Door  100% of door value counts toward credit
<b>Indoor Environmental Quality</b>				
4.4 (1 point)	<b>Low-emitting materials:</b> Composite wood and agrifiber products	Composite wood and agrifiber products used on the interior of the building must contain no added urea-formaldehyde resins.	Qualify—specify NAUF MDF	Qualify—specify NAUF MDF panel core

TruStile Doors help achieve LEED credits in the following categories for residential home construction projects<sup>2</sup>:

LEED credit	LEED criteria	Detailed requirement	TruStile MDF	TruStile Wood
<b>Materials &amp; Resources</b>				
2.2 (0.5 points for doors)	<b>Environmentally preferable products</b>	Use building component materials that are environmentally preferable in that they either contain minimum of 50% post industrial recycled content, are FSC certified or reclaimed.	Qualify—SCS certified to contain minimum 69% recycled content	Qualify—specify FSC Certified Wood Door  100% of door value counts toward credit

<sup>1</sup> LEED for New Construction & Major Renovations, Version 3 (April 2009).

<sup>2</sup> LEED for Homes Rating System, Version 2008 (January 2008).



60-MINUTE FIRE DOOR NON-RATED DOOR

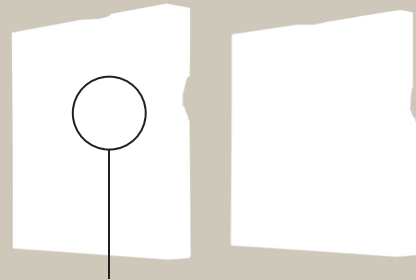

Profiles on fire-rated doors have true depth and definition, not plant-on mouldings.

## Our Fire Doors are as Stylish as They are Safe

Designed to match non-rated doors, all TruStile fire doors feature full panel relief and are carefully engineered to complement our non-rated doors.

Non-rated TS3070 in MDF



20-minute fire-rated TS3070 in MDF



### Matched Dimensions

Stile and rail dimensions can be matched between standard and fire-rated doors.

### Certified Fire Door Ratings

Throw away the preconception that you have limited design options for fire-rated openings. With most of our standard panel doors available in up to 90-minute ratings, you never have to sacrifice style when selecting 20- through 90-minute fire doors.

	20-minute MDF	20-minute Wood	45- and 60-minute MDF/Wood	90-minute MDF/Wood
<b>Category</b>	Category A Category B Neutral Pressure	Category A Category B Neutral Pressure	Category A Category B	Category A Category B
<b>Thickness</b>	1 3/4" minimum	1 3/4" minimum	1 3/4" minimum	1 3/4" minimum
<b>Maximum width single</b>	4'0"	4'0"	3'6"	3'6"
<b>Maximum width pair</b>	8'0"	8'0"	7'0"	7'0"
<b>Maximum height</b>	8'0"	8'0"	8'0"	8'0"
<b>Fire Glass max. area</b>	3,145 sq. inches	3,145 sq. inches	1,248 sq. inches – 45 minutes 1,216 sq. inches – 60 minutes	1,216 sq. inches
<b>Standards</b>	ASTM E-152, NFPA 80, NFPA 252, UL10B, UL10C			

\*Some door styles and panel profiles are not available in all fire ratings. Verify availability with TruStile.  
\*\*Some ratings require metal vision kits.

### Fire Rated Glass Doors Also Available

Glass doors are the perfect solution for spaces where a fire door is required by code, but the look of a glass door is preferred. Select from over 120 fire-rated glass doors with any of our standard sticking profiles. Refer to the fire-rated symbol  in the Door Collections section to see which glass door designs are available in 20-, 45-, 60- and 90-minute fire ratings. Hose stream-approved glass can also be specified.

TS4100 in Maple



20-minute fire-rated TS3190 in Walnut





**Keep Private Conversations Private**

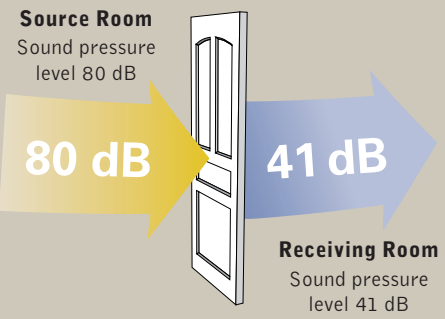

## Superior Sound Performance

Noise is an inescapable component of life in the modern home. Because of their weight, solid construction and high density, TruStile doors are the ideal solution to sound proofing a home.



Home theater featuring TS3070 in Mahogany with custom porthole window

## Sound Transmission Class (STC) Ratings

TruStile has tested its sound doors in operable openings with Zero International sound gasketing packages.

STC rating	Door material	Door styles	Door thickness	Primary seal	Secondary seal	Threshold saddle	Sweep
<b>Zero International hardware used</b>							
39	MDF and wood	60-minute fire door	2¼"	#475	#119	#564	#367
38	MDF	90-minute fire door	1¾"	#188FS	#118B	Flat surface	#369
34	MDF	20-minute fire door	1¾"	#188FS	#118B	Flat surface	#369
34	MDF	TS5000 — TS9000	1¾"	#475	#119	#564	#367
33	MDF	TS1000 — TS4000	1¾"	#475	#119	#564	#367
32	MDF	TS5000 — TS9000	1¾"	#475	N/A	#564	N/A
32	Wood	TS1000 — TS4000	1¾"	#475	#119	#564	#367
30	MDF	TS1000 — TS4000	1¾"	#475	N/A	#564	N/A
30	Wood	TS1000 — TS4000	1¾"	#475	N/A	#564	N/A
30	Wood	TS5000 — TS9000	1¾"	#475	#119	#564	#367

## Sound Transmission Class (STC) Examples

TruStile Advantage	STC	Performance	Description
	50 – 60	Excellent	Loud sounds heard faintly or not at all
	40 – 50	Very Good	Loud speech heard faintly
<b>TruStile Door with Correct Gasketing</b>	<b>35 – 40</b>	<b>Good</b>	<b>Loud speech heard but hardly intelligible</b>
	<b>30 – 35</b>	<b>Fair</b>	<b>Loud speech understood fairly well</b>
	25 – 30	Poor	Normal speech understood easily and distinctly
Typical Hollow-Core Door	20 – 25	Very Poor	Low speech audible

Sound ratings are classified by an STC (sound transmission class) number that rates a material's ability to resist airborne sound. A higher STC rating blocks more noise from transmitting through a partition like a door. Standard TruStile MDF doors achieve up to a 34 STC rating, some 10- to 15-points better than typical hollow-core doors that achieve a "very poor" rating. For openings requiring even better sound performance, TruStile can provide 60-minute wood and MDF fire doors that achieve up to a 39 STC rating.





TS3000 in Mahogany with Linea tiered moulding



TS3000 in MDF with White Lami glass

## The Extensive TruStile Door Collection

Find the ideal design that enhances your home's architectural style and completes its distinctive look.

**UNLIMITED  
POSSIBILITIES**

Choose from over 400 door styles and 66 profile options.





TS3080 in Knotty Alder

## TS Door Collection

Our TruStile (TS) Door Collection features over 100 architecturally-correct panel door styles from one- to nine-panel configurations. Each door is built with genuine stile and rail construction and is never routed or stamped. As a result, our panel doors have crisp, clean lines and unmatched detail.



TS3000 in MDF

### TS Series Door Styles

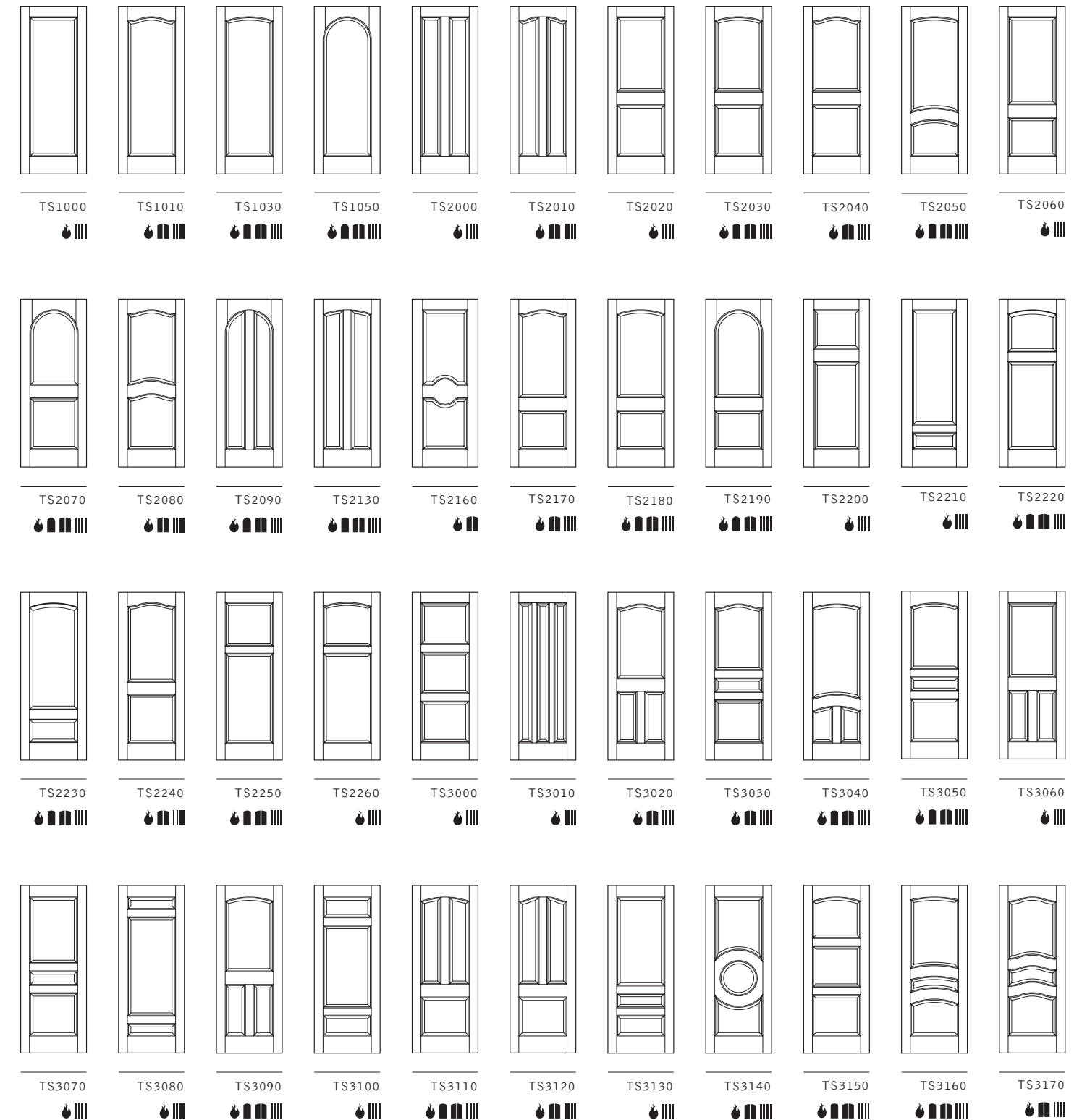

Available as a fire-rated door\*    
 Arch-top option available    
 Radius-top option available    
 Bi-fold closet option available  
 Available in MDF only

\*Contact TruStile to confirm exact fire ratings and available sizes



TS Series Door Styles

TS Series Door Styles

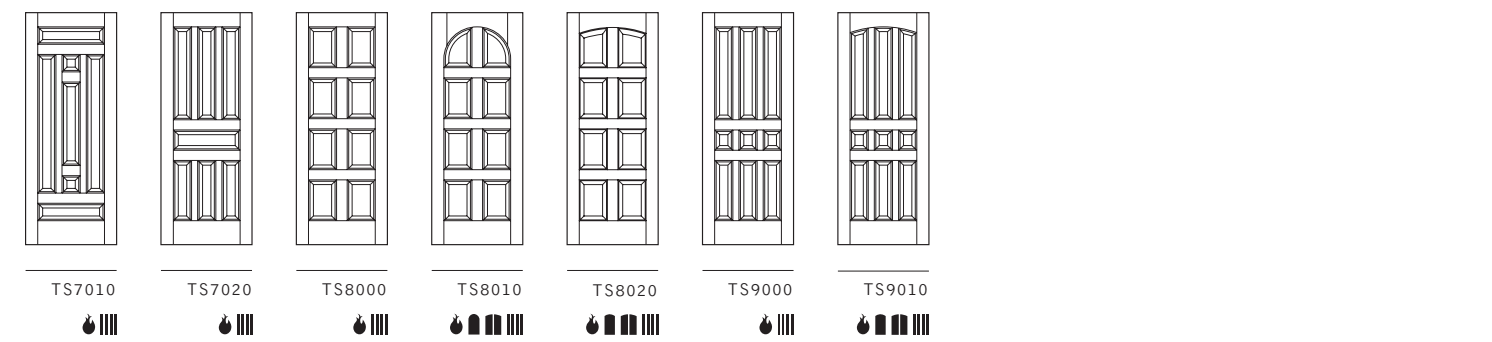
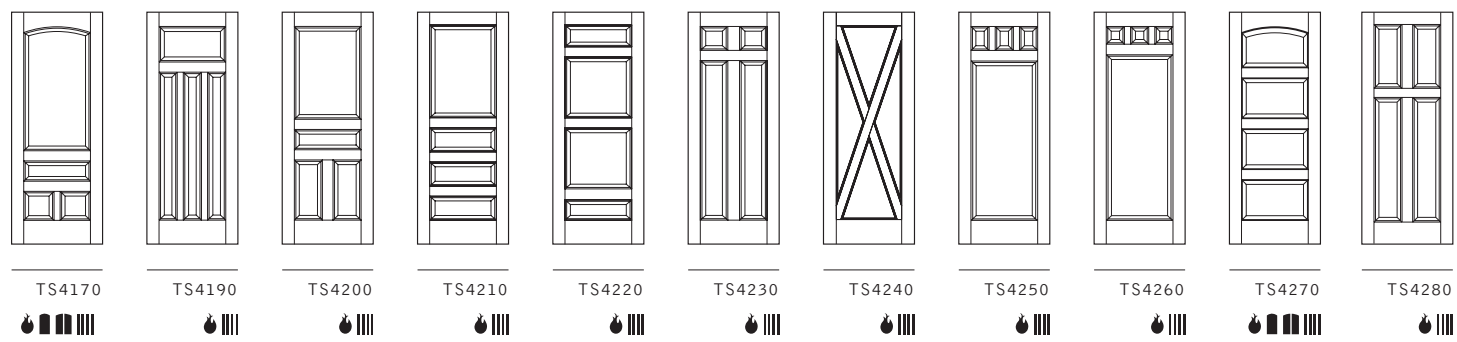
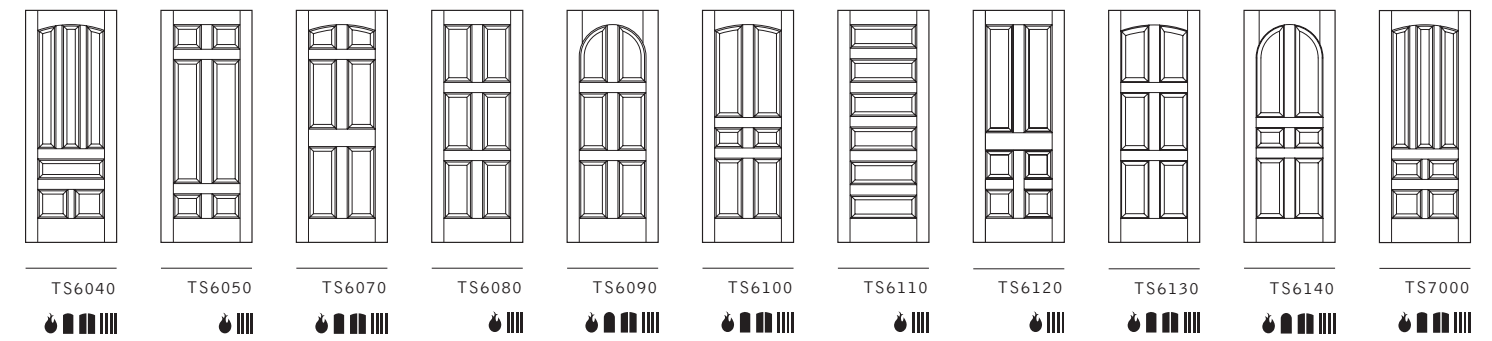
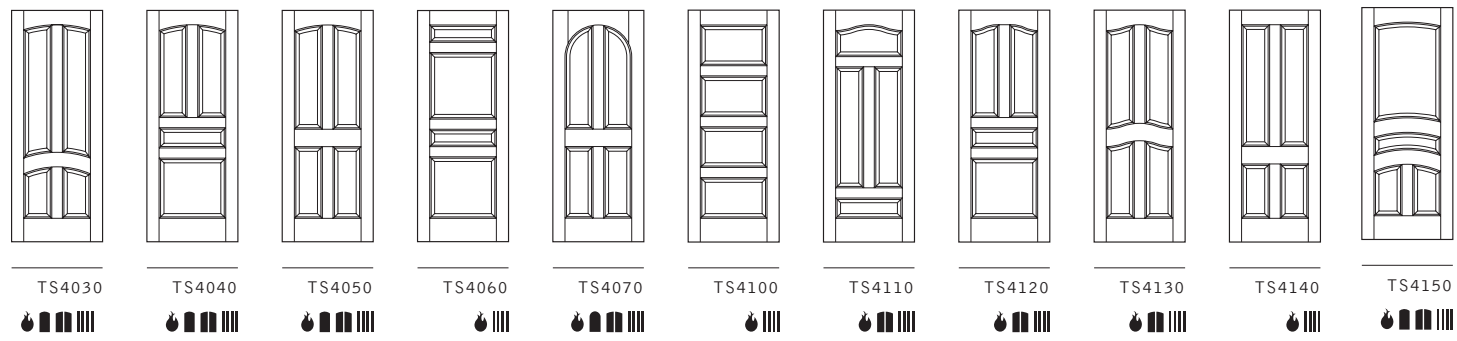
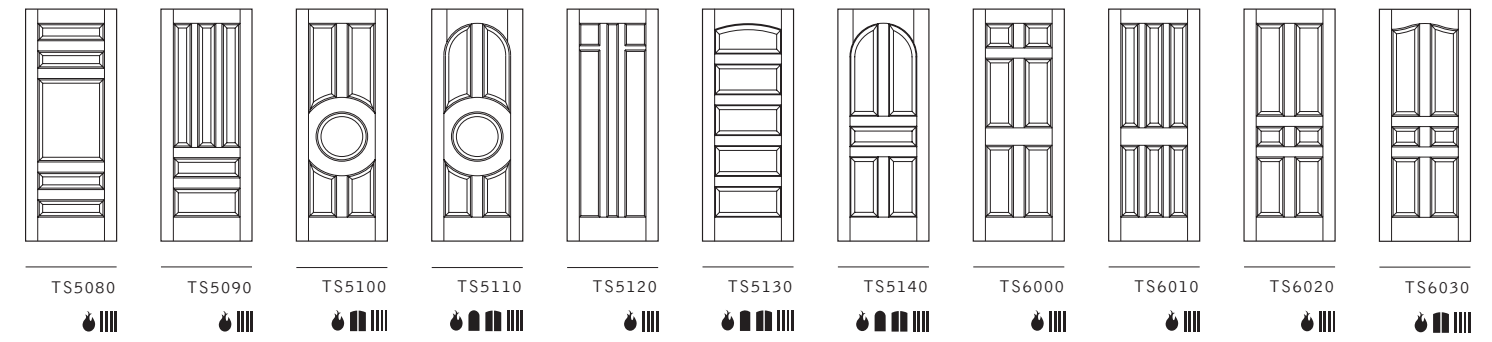
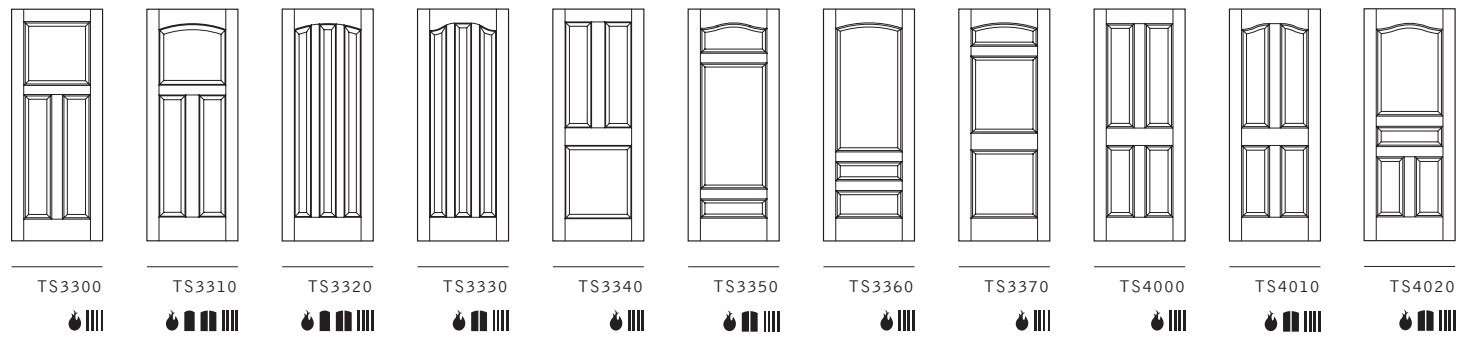
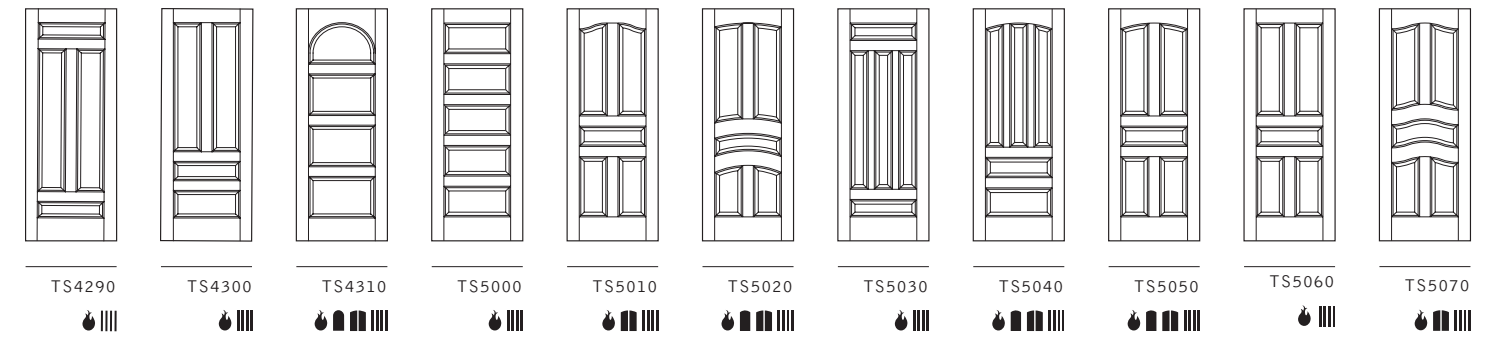
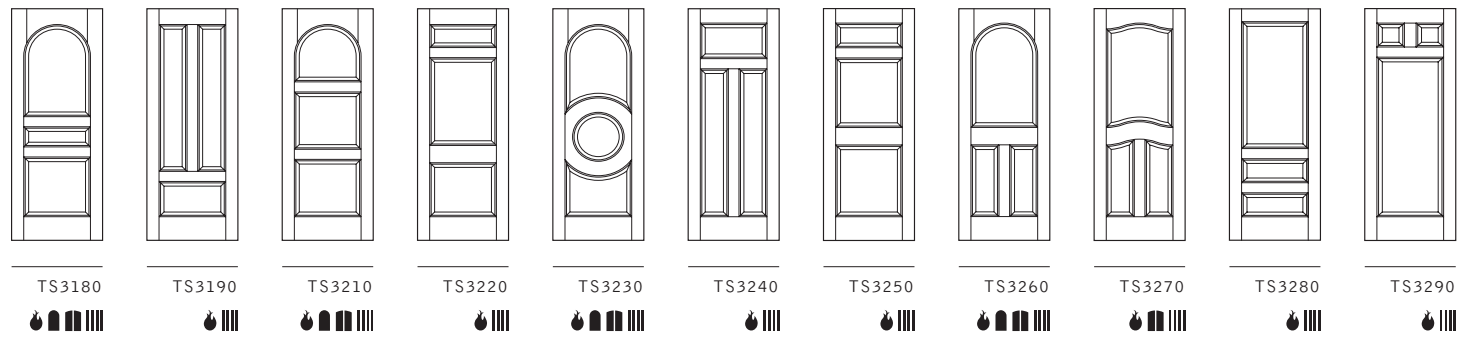

Available TruStile  
 Product Options  
 Available as a fire-rated door\*  
 Arch-top option available  
 Radius-top option available  
 Common arch pair option available  
 Bi-fold closet option available  
 Available in MDF only  
 \*Contact TruStile to confirm exact fire ratings and available sizes

Available TruStile  
 Product Options  
 Available as a fire-rated door\*  
 Arch-top option available  
 Radius-top option available  
 Common arch pair option available  
 Bi-fold closet option available  
 Available in MDF only  
 \*Contact TruStile to confirm exact fire ratings and available sizes



TS3070 in MDF with Roman Ogee (OG) sticking and Raised (A) panel



## Panel Door Profile Options

A door profile refers to the joint where the sticking and panel come together. You can achieve distinct looks by selecting different sticking and panel combinations. With so many combinations to choose from, we're confident you'll find the perfect profile for your project. If not, we can partner with you to create a custom profile.

### Sticking Profile Options

Roman Ogee (OG)

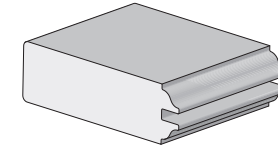

Cove & Bead (CB)

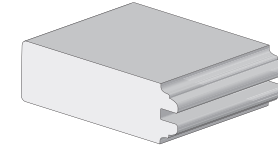

Quarter Bead (QB)

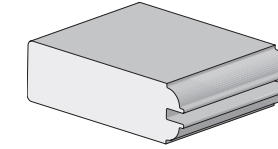

Quarter Round (QR)

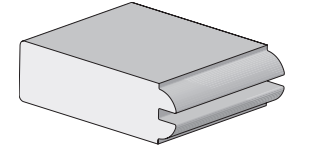

Bevel (BV)

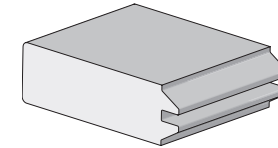

Square Stick (SS)

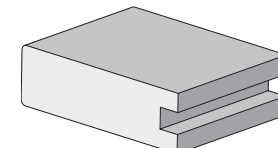

One Step (OS)

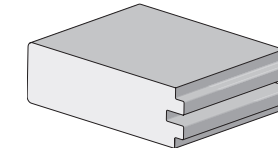

Quirk Moulding (QM)

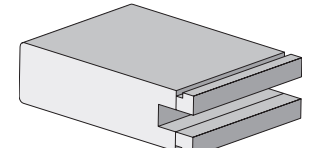

Low Profile Bolection Moulding (LP)

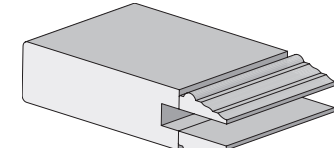

Bolection Moulding (BM)

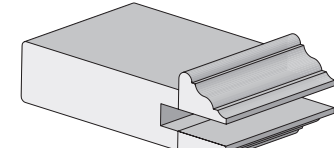

Big Bolection Moulding (BBM)

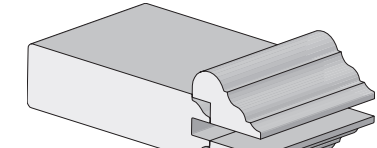

Miracle (MR) Applied Moulding

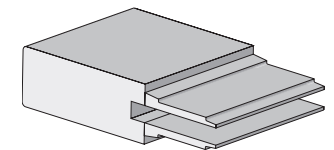

Avant (AV) Applied Moulding

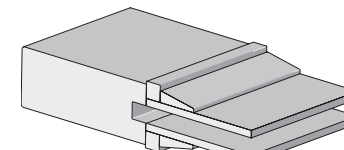

Linea (LN) Applied Moulding

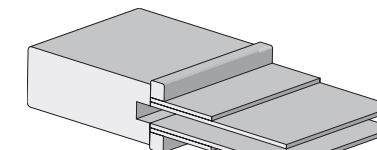

### Panel Profile Options

"A" Raised Panel

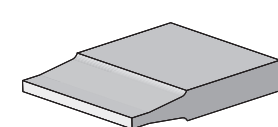

"B" Scoop Panel

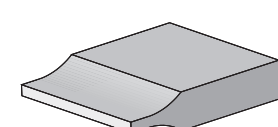

"C" Flat Panel

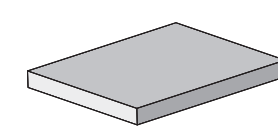

"D" Double Hip Panel

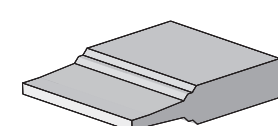

"E" Senior Raised Panel

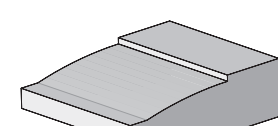

"F" Senior Bevel Panel

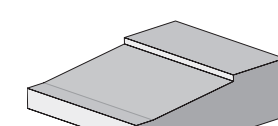





## TM Door Collection

The Tru&Modern™ (TM) Door Collection consists of over 100 contemporary door styles. A modern take on classic stile and rail door construction. Clean, strong lines. Custom design options. Bold accents. This collection radically alters the concept of what a door can bring to today's modern and contemporary interiors.



### TM Series Door Styles: New Configuration Door Series

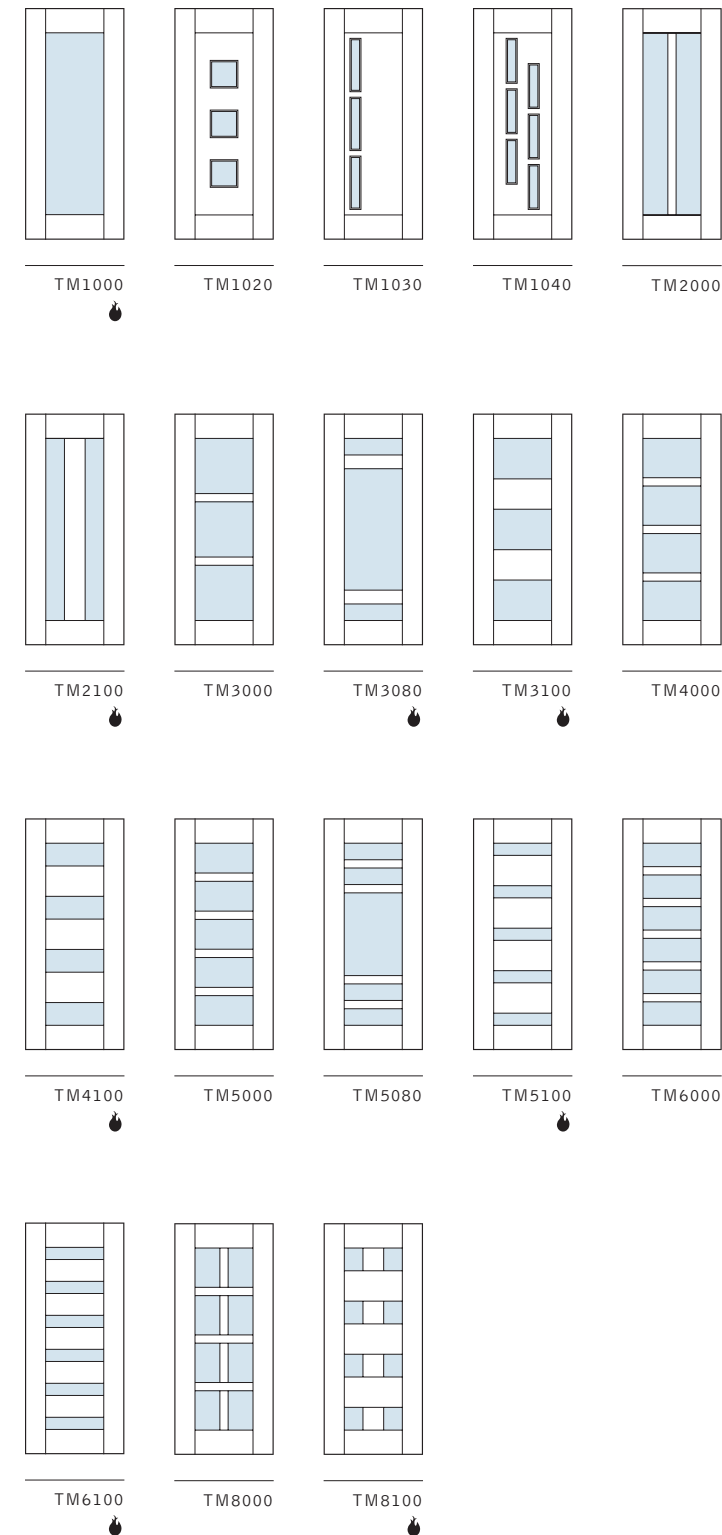

### Tru&Modern Profile Options

TM New Configuration door designs are available with two profile options to frame the desired insert:

#### Square Stick (SS) Compression Fit

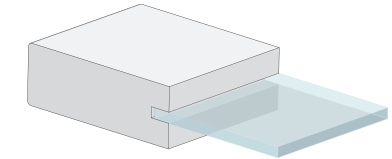

Compression fitting not available for leather inserts. Glass can not be replaced on compression fit doors.

#### Square Stick (SS) Sash

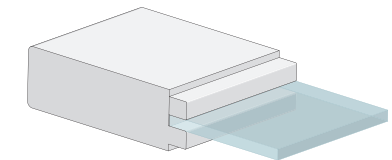

Square Stick sash not available for wood panels. Use One Step (OS) sticking to match Square Stick (SS) sash around wood panels.

**Note:** Door styles are shown with the new modern wide stile. Shaded panels indicate an insert option: leather, metal, glass, resin or a flat wood panel.

Available TruStile  
Product Options

Available as a fire-rated door\*  
Arch-top option available

Radius-top option available  
Common arch pair option available

Bi-fold closet option available  
Available in MDF only

\*Contact TruStile to confirm exact fire ratings and available sizes



TM Series Door Styles:

**9 Stacked Rail Series**

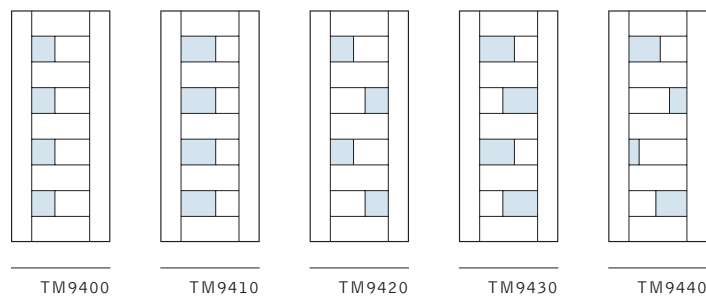
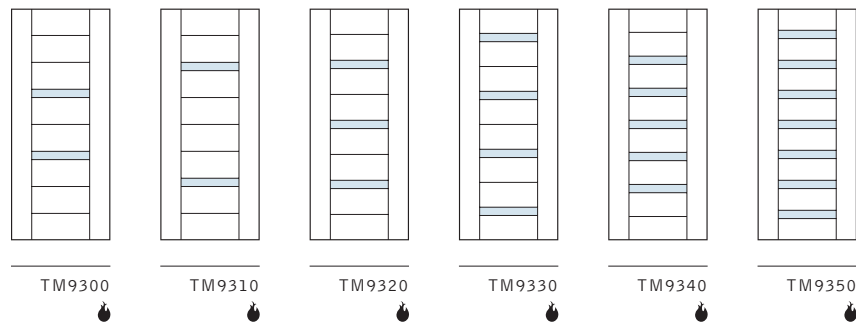
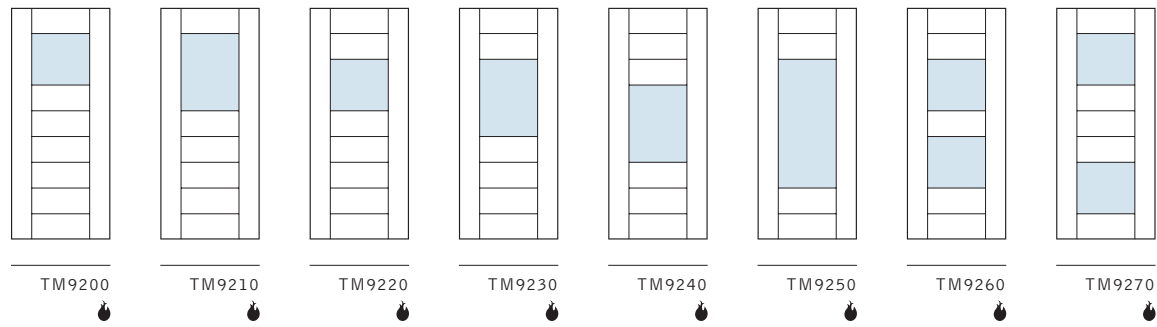
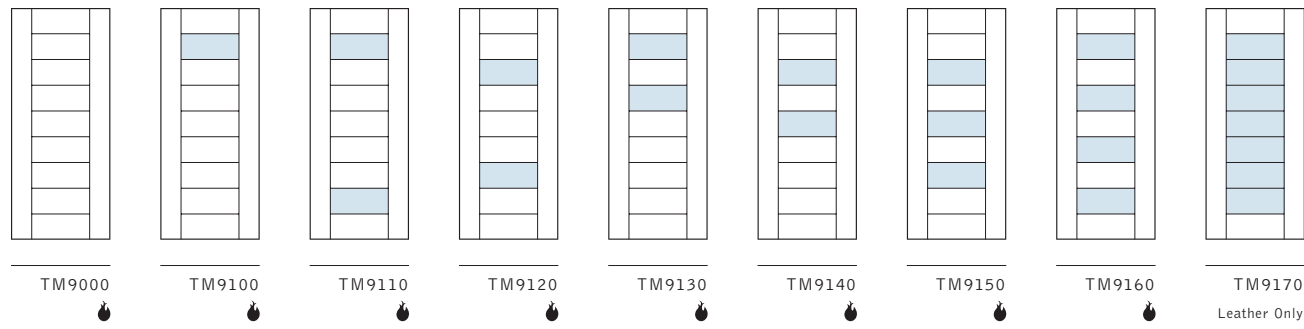

**Tru&Modern™ Series Reveals**

TM stacked rail door designs are available with two reveal options:

**1/8" Radius Reveal**

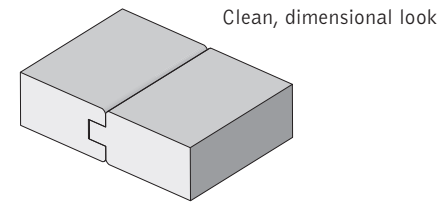

**1/4" Kerf Cut Reveal**

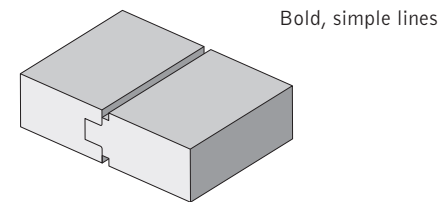

TM Series Door Styles:

**13 Stacked Rail Series**

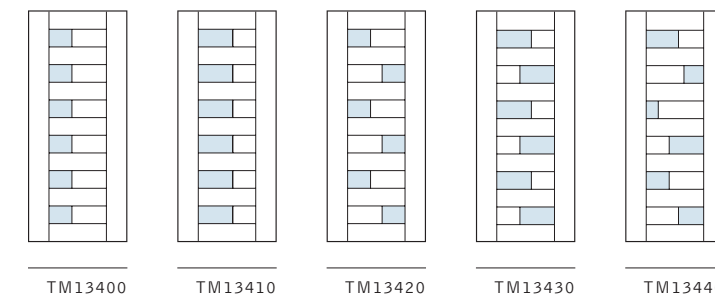
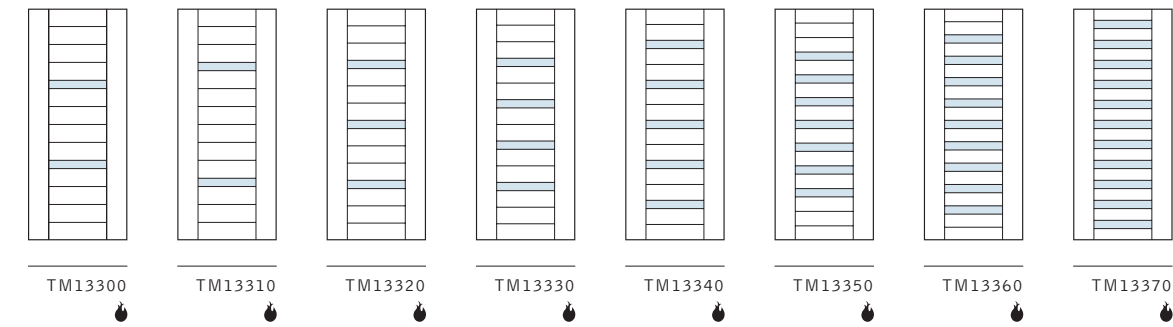
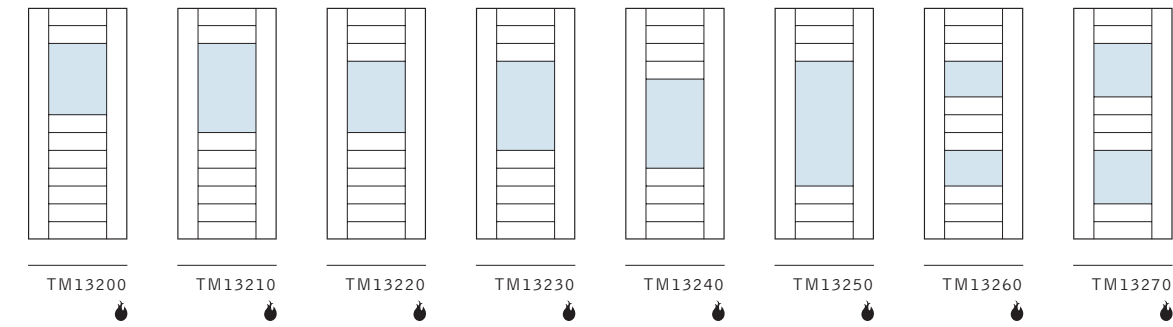
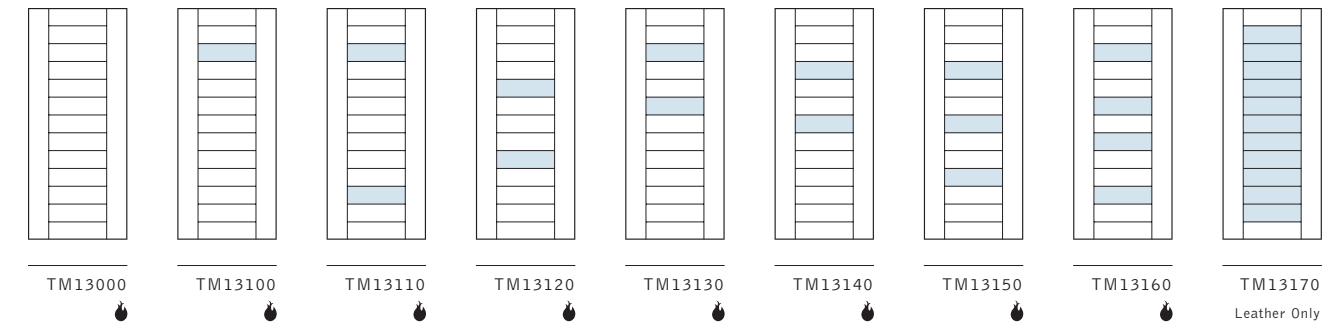

**Note:** Door styles are shown with the new modern wide stile. Shaded panels indicate an insert option: leather, metal, glass, resin or a flat wood panel.

- 🔥 Available as a fire-rated door\*
  - 🔱 Radius-top option available
  - 🚪 Bi-fold closet option available
  - 🏠 Arch-top option available
  - 🏠 Common arch pair option available
  - 🌀 Available in MDF only
- \*Contact TruStile to confirm exact fire ratings and available sizes

- 🔥 Available as a fire-rated door\*
  - 🔱 Radius-top option available
  - 🚪 Bi-fold closet option available
  - 🏠 Arch-top option available
  - 🏠 Common arch pair option available
  - 🌀 Available in MDF only
- \*Contact TruStile to confirm exact fire ratings and available sizes





TMIR6080 in mahogany with Espresso stain and 1/2" bright stainless steel inlay

## TMIR Collection

Modern architecture demands exacting specifications. The Tru&Modern

Infinite Rail brings a luxurious level of sophistication with kerf cuts or metal inlays that traverse the complete width of the door.



TMIR6000 in walnut with Nutmeg stain and 1/4" kerf cut reveal

## TMIR Series Door Styles

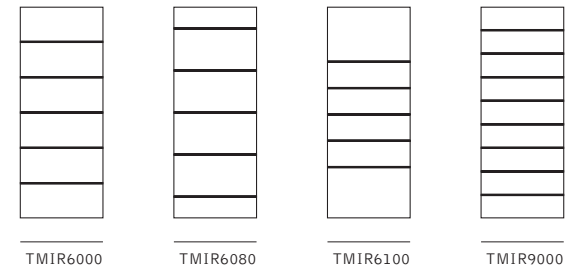
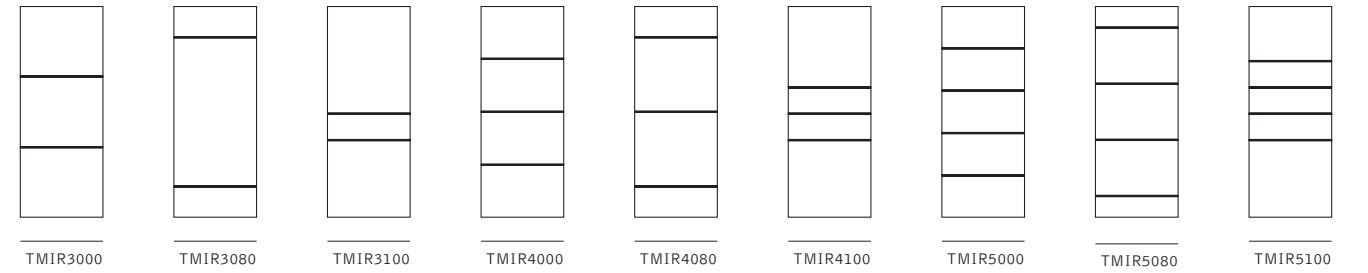

## TMIR Series Profiles

TMIR Infinite Rail doors are available with the following profiles:

### 1/4" Kerf Cut Reveal

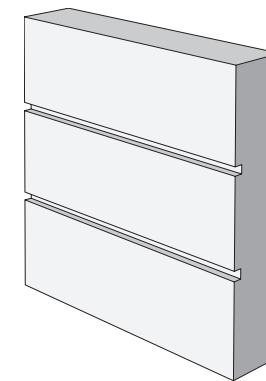

### 1/2" Stainless Steel Inlay

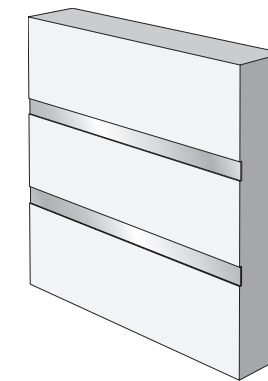

Available with bright or brushed stainless steel





FL300 in MDF with Bevel glass

## FL Door Collection

Our French Door (FL) Collection offers 100 classic glass door designs from one- to 18-lite configurations. Our French Doors are crafted with true divided lites. Each individual piece of glass is hand-inserted for maximum architectural detail.



FL840 in Cherry with Groove glass

## FL Series Door Styles

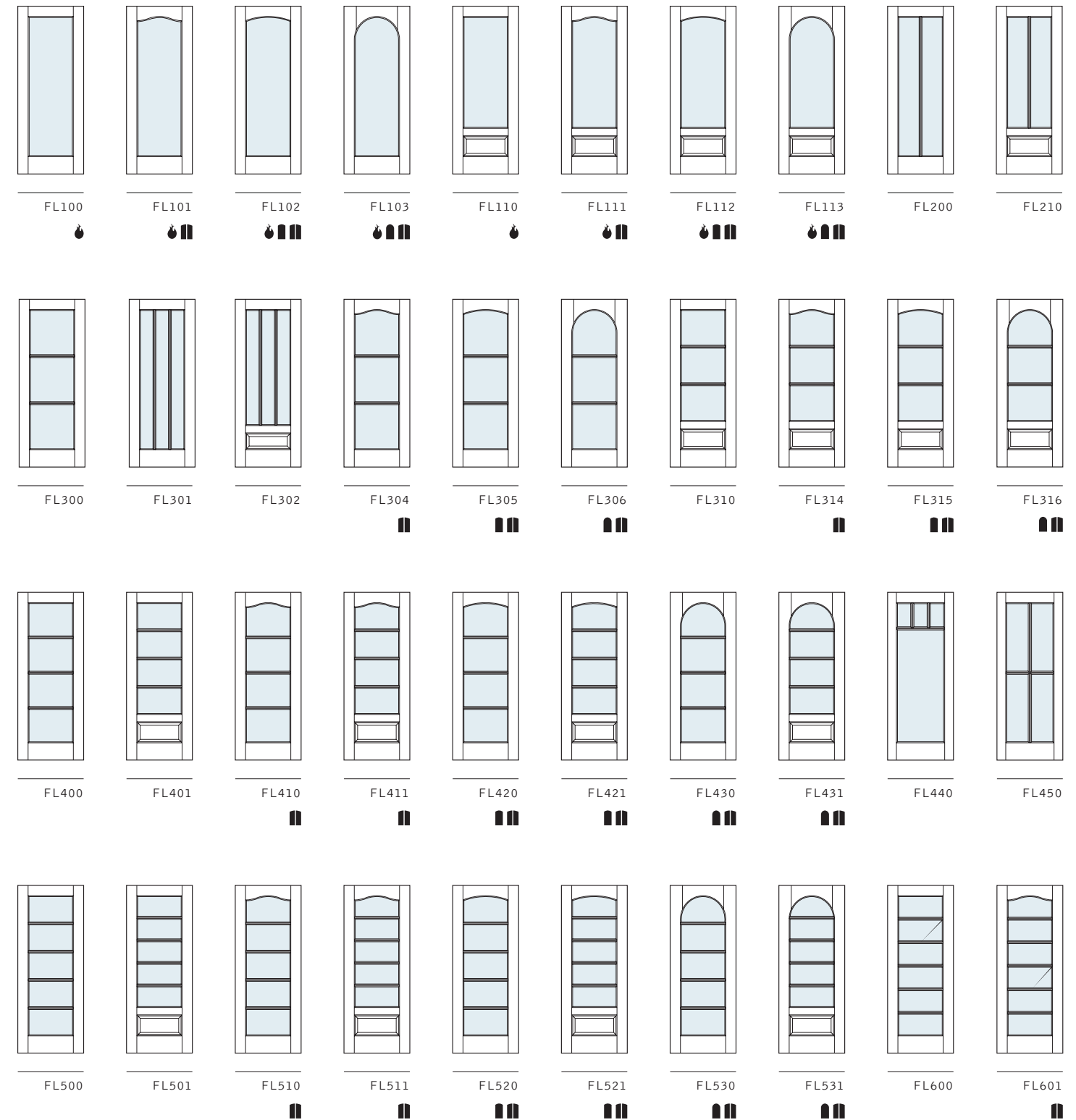

- Available TruStile Product Options
- Available as a fire-rated door\*
- Arch-top option available
- Radius-top option available
- Common arch pair option available
- Bi-fold closet option available
- Available in MDF only

\*Contact TruStile to confirm exact fire ratings and available sizes



FL Series Door Styles

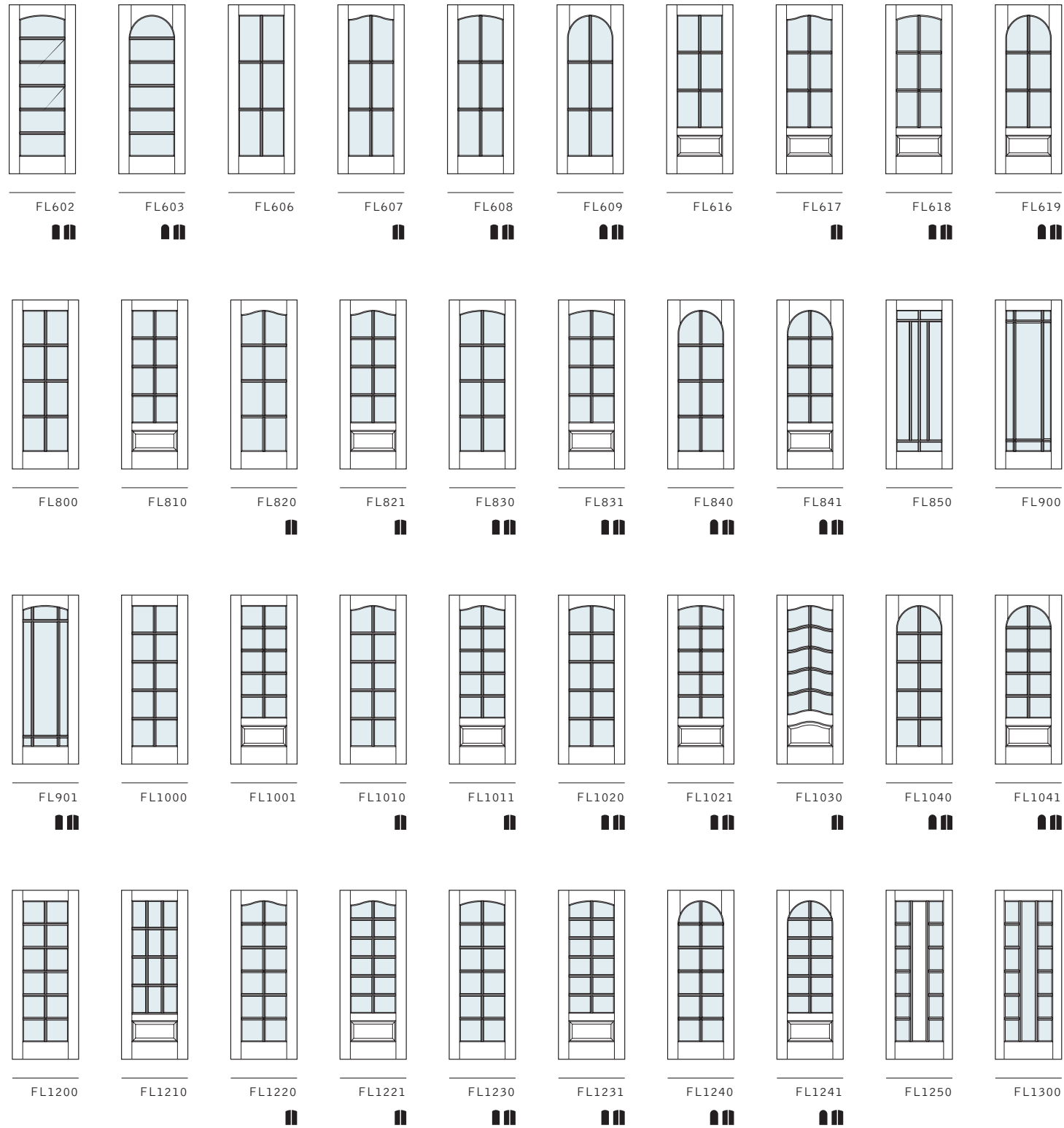

Available TruStile Product Options  
 Available as a fire-rated door\*  
 Arch-top option available  
 Radius-top option available  
 Common arch pair option available  
 Bi-fold closet option available  
 Available in MDF only  
 \*Contact TruStile to confirm exact fire ratings and available sizes

FL Series Door Styles

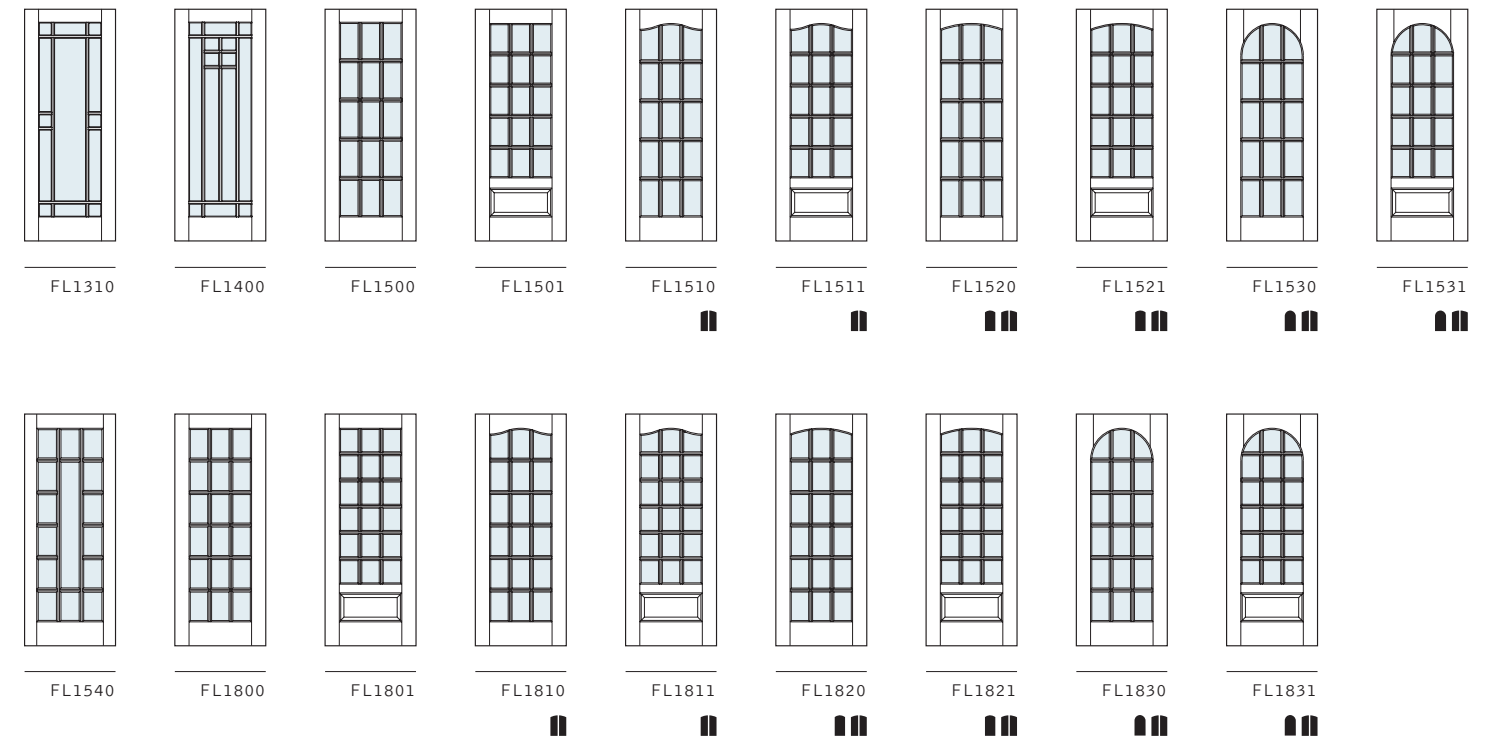

Available TruStile Product Options  
 Available as a fire-rated door\*  
 Arch-top option available  
 Radius-top option available  
 Common arch pair option available  
 Bi-fold closet option available  
 Available in MDF only  
 \*Contact TruStile to confirm exact fire ratings and available sizes





## PL Door Collection

Our Panel Lite (PL) Door Collection combines raised panels with glass lites, giving you the best of both styles. A popular selection for pantries, bathrooms and entries, panel lite doors can be used for both interior and exterior applications.



### PL Series Door Styles



- Available TruStile Product Options
- Available as a fire-rated door\*
- Arch-top option available
- Radius-top option available
- Common arch pair option available
- Bi-fold closet option available
- Available in MDF only

\*Contact TruStile to confirm exact fire ratings and available sizes



PL Series Door Styles



# Glass Door Profile Options

The following sash and compression fit options are available to match our panel door profiles.

## Glass Door Profile Options

Reverse Roman Ogee (OG) Sash

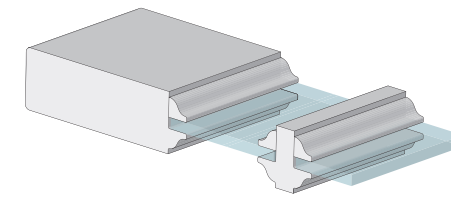

Narrow Reverse Roman Ogee (OG) Sash\*

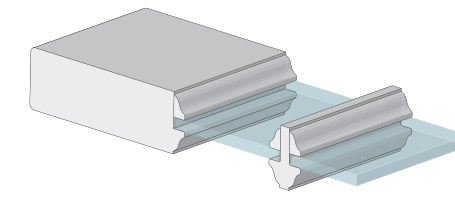

Cove & Bead (CB) Sash

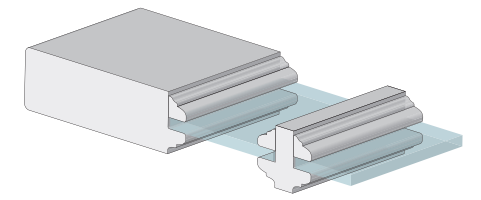

Quarter Bead (QB) Sash

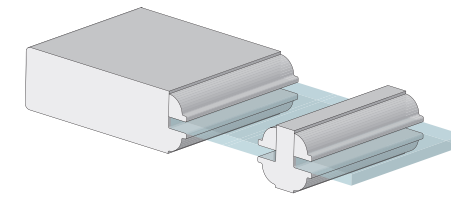

Quarter Round (QR) Sash

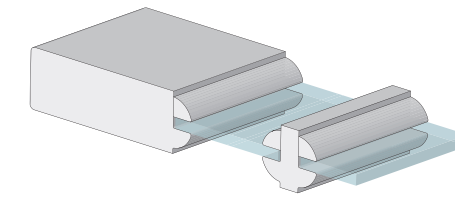

Bevel (BV) Sash

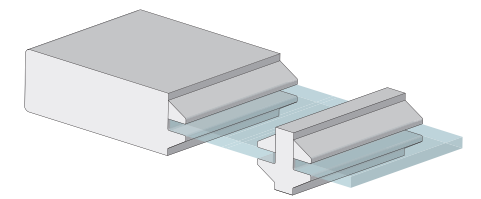

Square Stick (SS) Sash

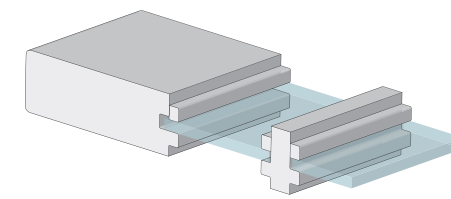

Square Stick (SS) Compression Fit\*\*

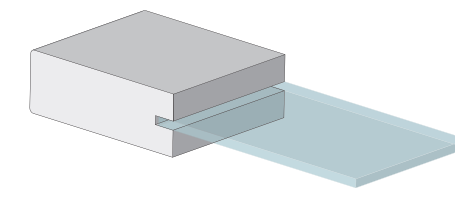

Quirk Moulding (QM) Compression Fit\*\*

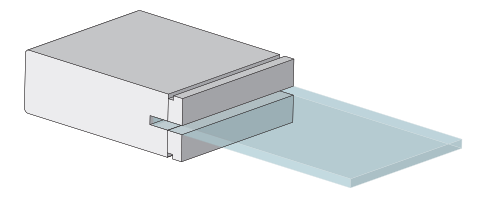

One Step (OS) Sash

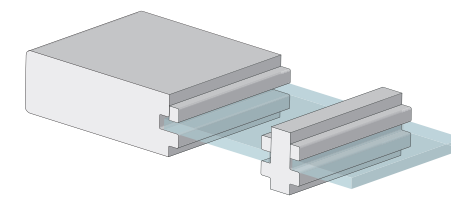

Applied Raised Moulding (ARM)

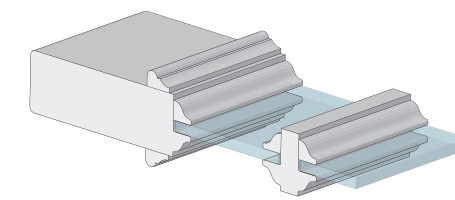

- Available TruStile Product Options
- Available as a fire-rated door\*
- Arch-top option available
- \*Contact TruStile to confirm exact fire ratings and available sizes
- Radius-top option available
- Common arch pair option available
- Bi-fold closet option available
- Available in MDF only

\* Optional 3/8" narrow muntin bars available only on interior doors with 1/4" glass.  
 \*\* On compression fit doors, glass cannot be replaced if broken.











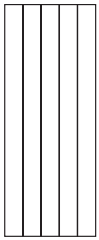
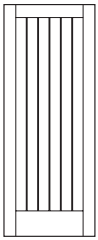
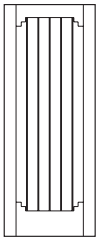
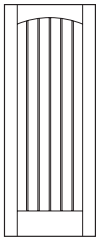
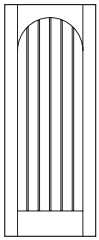
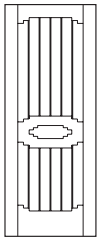
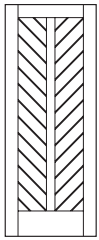
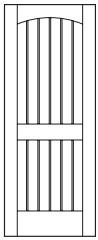
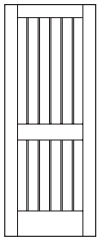
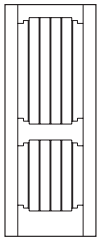









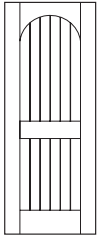
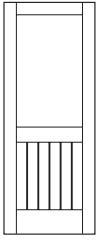
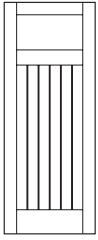
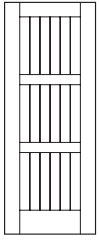
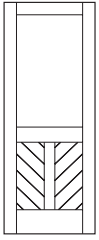
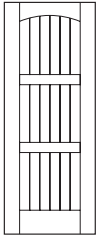
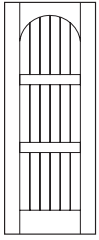
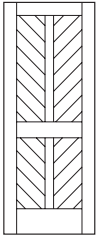
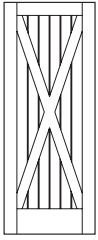
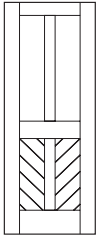





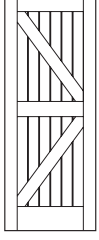
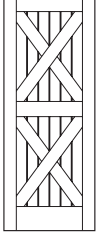
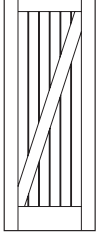
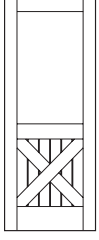
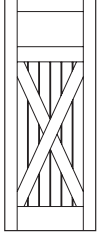

# V-Groove Door Collection

Our V-Groove (VG) Door Collection features a tongue-and-groove look that emulates plank doors. Each door is built with genuine stile and rail construction to ensure greater performance than plank doors.



## VG Series Door Styles

									
VG1000	VG1010	VG1020	VG1030	VG1040	VG2000	VG2010	VG2020	VG2030	VG2040
									
									
VG2070	VG2100	VG2150	VG3000	VG3010	VG3020	VG3030	VG4000	VG4010	VG4020
									
									
VG4030	VG4040	VG4050	VG4100	VG4150					
									

### Plank Door Profiles (VG1000)

Plank doors are available with standard and wide plank spacing and the following profiles:

Standard V-Groove Profile

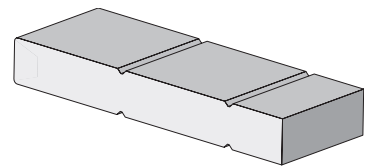

Wide V-Groove Profile

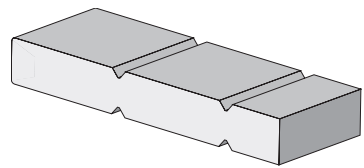

### V-Groove Series Profiles

V-Groove doors come with one of the following standard profiles:

Standard V-Groove Profile

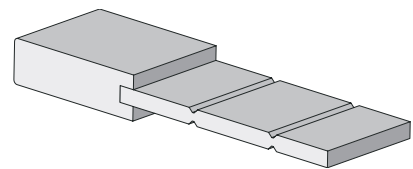

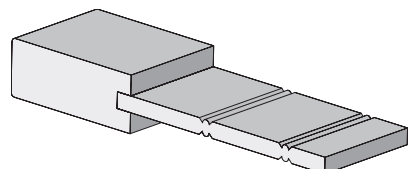

Beaded V-Groove Profile (Optional)





 Available TruStile Product Options

 Available as a fire-rated door\*

 Arch-top option available

 Radius-top option available

 Common arch pair option available

 Bi-fold closet option available

 Available in MDF only

\*Contact TruStile to confirm exact fire ratings and available sizes





## Tambour Door Collection

Our Tambour (TMB) Door Collection combines stile and rail construction with state-of-the-art CNC routing technology to create a uniquely contemporary look.

Combine these doors with other styles for design interest and visual variety.

### TMB Series Door Styles

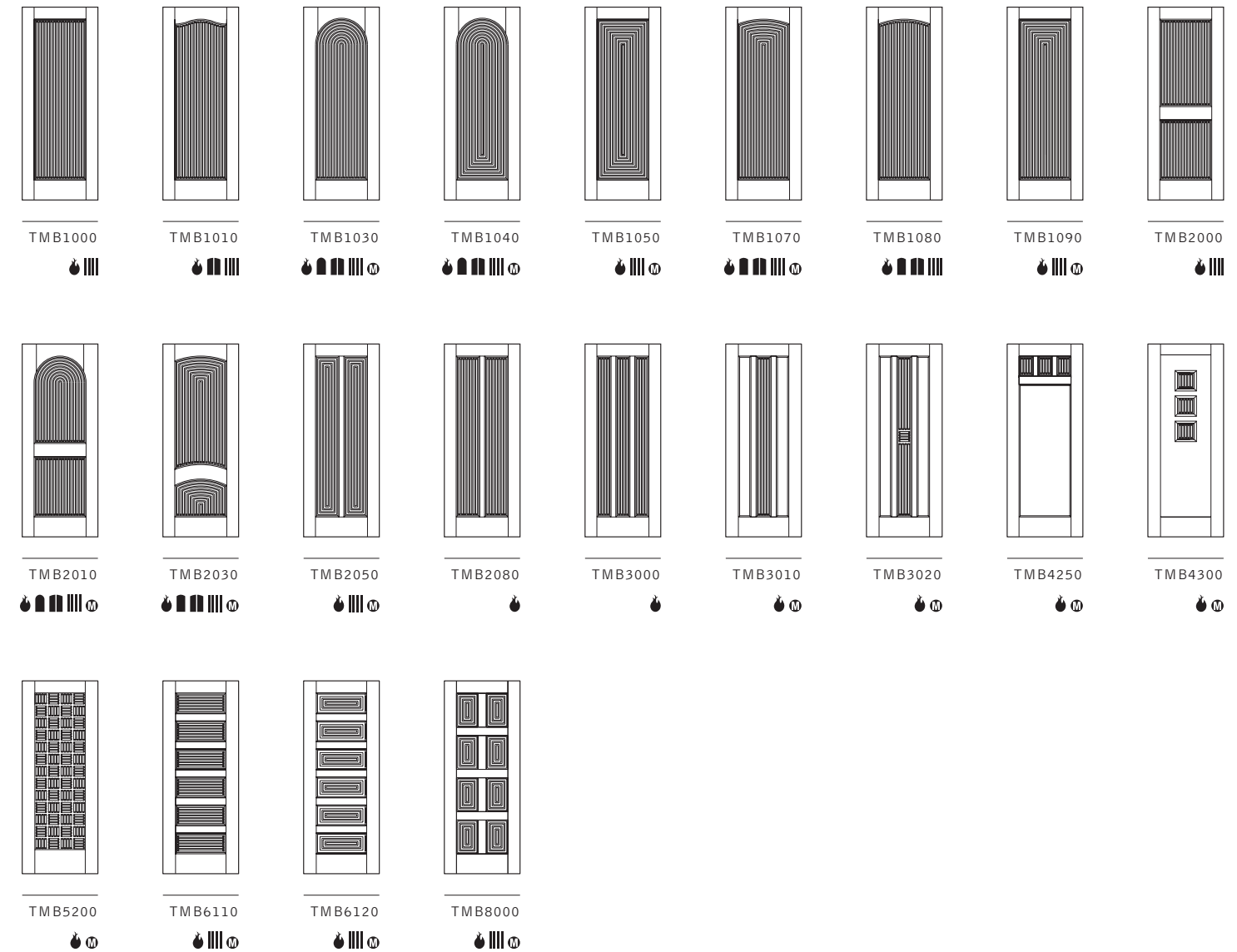

### Tambour Door Profile Options

Choose from Half-round and Bevel profile options for Tambour doors in MDF. Half-round is our standard profile for Tambour wood doors.

#### Half-round

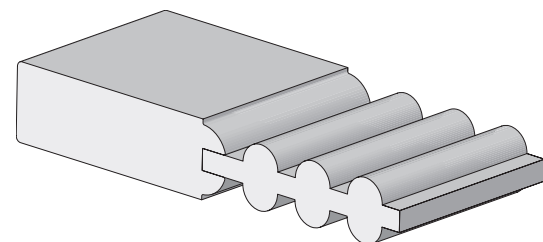

#### Bevel (MDF Only)

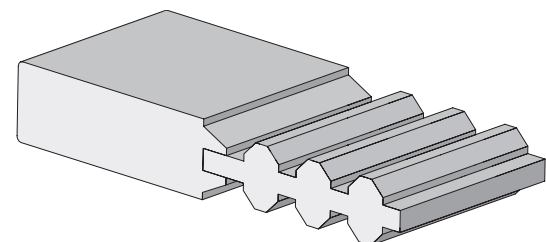

- Available TruStile Product Options
- Available as a fire-rated door\*
- Arch-top option available
- Radius-top option available
- Common arch pair option available
- Bi-fold closet option available
- Available in MDF only

\*Contact TruStile to confirm exact fire ratings and available sizes



## Custom Design Door Collection

Our Custom Design (CD) Collection features an eclectic mix of custom styles from our design team. These exclusive TruStile designs fulfill a variety of architectural styles and are perfect for creating a dramatic visual impact. TruStile's Custom Design Collection proves that doors can be just as exciting as other home design elements.



AD3030 in MDF and White Lami glass with custom star-shaped plant-ons

### CD Series Door Styles

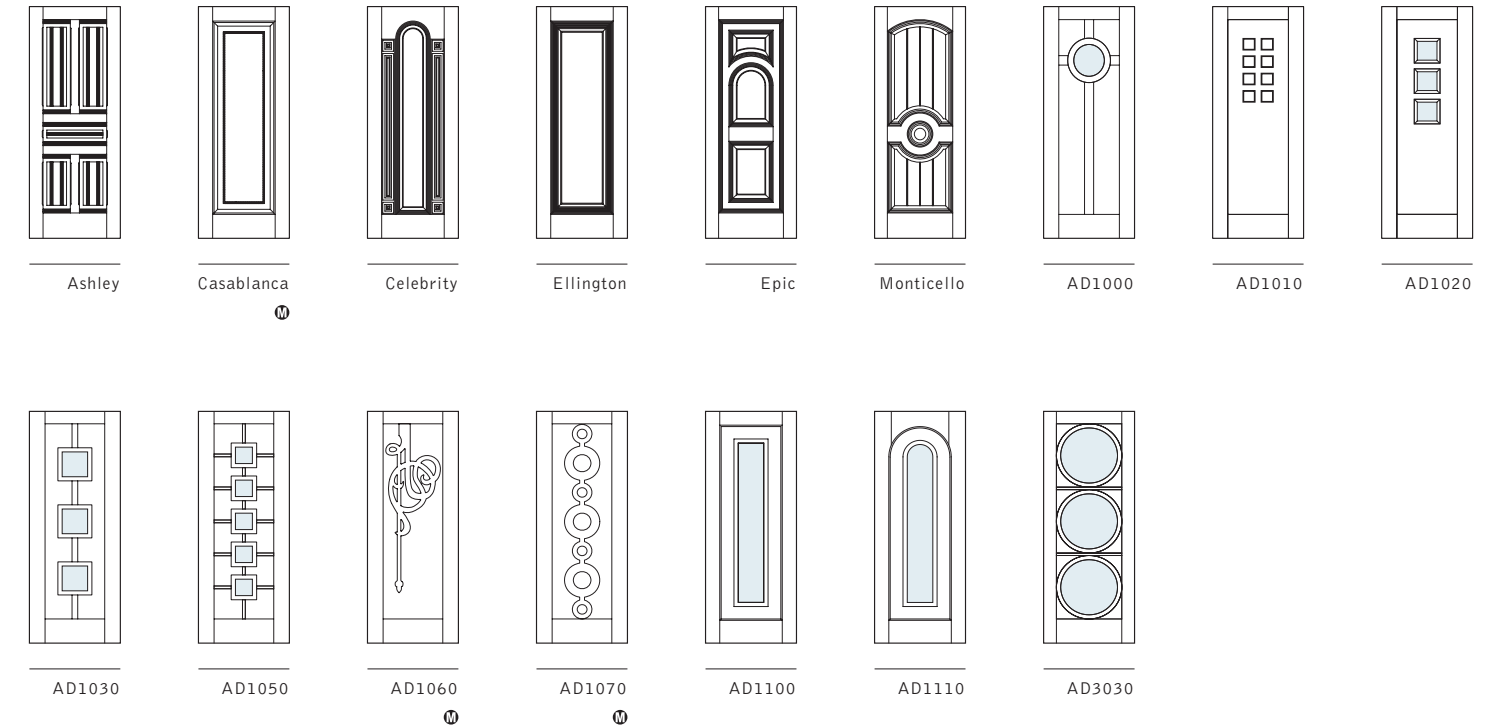

Available in MDF only



LVR2020 in MDF

## Louver Door Collection

Our Louver (LVR) Door Collection creates architectural interest and enhances a variety of styles. These plantation-style louver doors feature fixed, over-sized louvers in vented and false configurations.

### Vented Louver Doors

Vented louver doors permit air flow making them ideal for closets and laundry rooms where ventilation is preferred.

### False Louver Doors

False louver doors are ideal for applications where a louver look is desired, but total privacy is a necessity.

### LVR Series Door Styles

#### Vented Louver

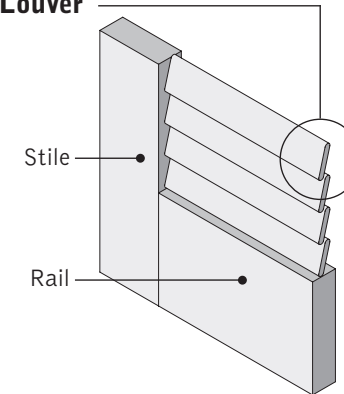

#### False Louver

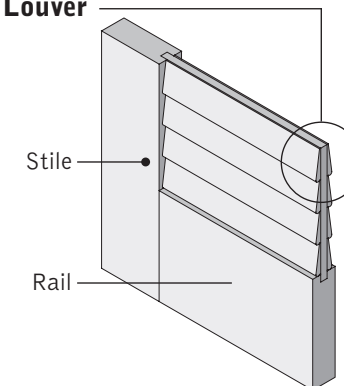

#### Visible Louver Dimensions

Vented: 2"  
False: 2"

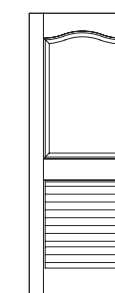
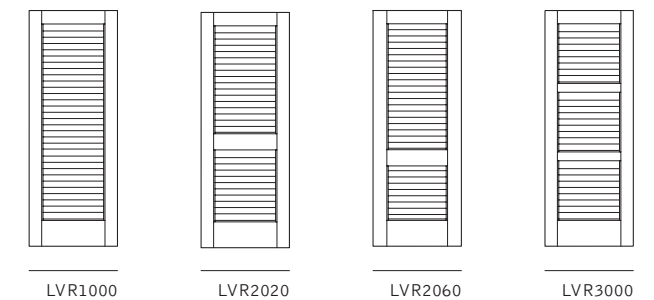

Example of TS2040 with bottom panel replaced with a louver panel.



Our TruCAD®  
Door Design Tool  
Allows Complete  
Customization

With TruStile's exclusive web-based software, you can design your own custom door. Specify the height, width and location of all the stiles, rails and mullions within a door.

Make your door your own at [www.trustile.com/doorsdesigntool](http://www.trustile.com/doorsdesigntool).

TM9420 in MDF with  
Satin Barcode glass  
(custom horizontal glass  
pattern direction)



Elevate your next project with our architecturally correct doors. Each unifies transitions, completes the interior design scheme and adds value to the project.





FOLLOW US



[www.trustile.com](http://www.trustile.com)

Front Cover: VG4010 barn door in wire-brushed white oak and TS4240 door in MDF and White Lami glass.

Back Cover: TM13340 in walnut with 1/4" kerf cut reveal and White Lami glass.



Full Line Architectural Catalog 03/14 © 2018 TruStile Doors, LLC. ® and ™ are trademarks of TruStile Doors, LLC.  
Select hardware provided by Emtek Products, Hafele America and Rocky Mountain Hardware.

**TRUSTILE DOORS, LLC**  
1780 East 66th Avenue  
Denver, CO 80229  
888.286.3931